

## DEEP CYCLE AGM

D.C VRLA AGM SERIES



HEADQUARTERS  
SCHOLIOU 6, IONIA,  
THESSALONIKI, GREECE  
PC: 57 008 PO BOX: 485  
T.: +30 2310 785722  
F.: +30 2310 760882



info@northbatt.com



www.northbatt.com

# Power for Life

## GENERAL INFORMATION



### Deep Cycle AGM D.C VRLA AGM Series

**Northbatt** Deep Cycle AGM series is designed for repeated Deep Cycle use, to be discharged and recharged hundreds of times. The consistency performance of group usage (groups with multiple connections) is much better than of other general series, making D.C AGM ideal for heavy duty applications.

It is made with updated AGM VRLA technology from pure materials with excellent know how to meet all needs, providing excellent cyclic and recovery performance after over-discharging.

**Northbatt** Deep Cycle AGM differs from conventional VRLA batteries, as it contains more lead, heavier plates and other special materials that enable to deliver more power and capacity over many charging cycles. The use of a special plate curing process for 10 days and extra superior pasting to the grids, ensuring long service life and fast recovery from deep discharge.

**Positive plate:** The positive plates are composed of a grid frame of heavy duty lead - tin - calcium alloy and active material of porous lead dioxide.

**Negative plate:** The negative plates are composed of a grid frame of Pb-Ca alloy and active material of spongy lead.

**Separator:** The separators made of non - woven fabric of fine glass fibers are chemically stable in the electrolyte sulfuric acid. The high porousness fully absorbs the electrolyte and prevents shorting between positive and negative plates. Terminal structure: Terminals are protected by a structure which secures long adhesive - embedded paths and by the use of strong epoxy material.

**Casing:** The unique construction and sealing techniques of **Northbatt** Deep Cycle AGM series guarantee leak proof operation in any position with no adverse effect to capacity or service life. The battery case is made from ABS or enhanced PP material and is shock resistant.

**Northbatt** Deep Cycle AGM batteries are designed for a long service life in cyclic applications, up to 1200 cycles for 50% Depth Of Discharge, or more than 10 years lifetime in float charge operation. All models comply to IEC 60896-21/22, IEC 61427, BS 6290 part IV standards.

## FEATURES D.C VRLA AGM Series

- **Sealed construction/Maintenance Free.** No need of separate battery room.
- **Free from Orientation Constraints** The sealed construction allows battery to be installed in any position, indoors or in a cabinet.
- **Eco Friendly:** The unique gas recombination technology effectively nullifies generation of gas during normal use.
- **Minimal Voltage Drop:** Since battery emits no gases or fumes, it can be placed next to the inverter or UPS system ensuring minimal voltage drop & transmission losses between battery and equipment, higher efficiency, lower power consumption and cost of cabling.
- **Easy Handling - Easy Installation:** Lightweight and compact. Modular construction, easy to install, connect and commission.
- **Excellent Service Life:** More than 10 years lifetime for float applications, 1200 charge/discharge cycles for cyclic use at 25°C.
- **Low Self Discharge:** Can be stored for 3 to 6 months, depending on ambient temperature before recharge and without any loss of efficiency or performance. Lower consumption of electricity during use.
- **Charge Retention & Recovery:** Excellent charge retention and recovery ability due to special design of plates and separators with an absolutely balanced electrolyte. Greatly improved ability to recover from deep discharge (5 hours) from 70% Depth of Discharge.
- **Superior High Rate Discharge:** Very low internal resistance and very high electrolyte - active material reactive interface - allows very high currents for short and medium duration. Requires smaller capacity for high rate discharges up to 15 mins/30 mins/ 60 mins duration.
- **High Reliability:** Tough construction and heavy duty design with superior corrosion resistant lead calcium tin alloy. Lower size, lower cost, lower space requirement. Can deliver the rated performance throughout its service life



## APPLICATIONS D.C VRLA AGM Series

- Off-Grid solar systems
- Marine signaling/service applications
- UPS systems - Road lights
- RV service applications
- Wheelchairs – scooters – Lawn mowers
- Electrical powered tools
- Communication & Emergency back-up systems

# RANGE SUMMARY

UNIBAT D.C AGM SPECIFICATION TABLE

BATTERY TYPE	V	CAPACITY @ 25°C (AH)		DIMENSIONS (MM)			WEIGHT (KG)	CONT. & LID MATERIAL	LAYOUT	TERMINALS	RI (MΩ)	MAX DISCHARGE CURRENT (A)
		C20 @ 1,80 V <sub>pc</sub>	C100 @ 1,85 V <sub>pc</sub>	L	W	H						
D.C 18 - 12A	12	18	22	181	76	167	5,2	ABS	F1	M5	15	225
D.C 26 - 12A	12	26	32	178	124	179	9,9	ABS	F2	M5	10	390
D.C 42 - 12A	12	42	51	200	165	170	14,8	PP	F3	M5	8	420
D.C 65 - 12A	12	65	78	350	166	174	21,6	PP	F4	M6	6	500
D.C 75 - 12A	12	75	90	391	166	174	24,7	PP	F4	M6	6	560
D.C 100 - 12A	12	100	120	407	173	235	33,0	PP	F4	M8A	6	600
D.C 120 - 12A	12	120	144	452	172	239	39,7	PP	F5	M8B	6	720
D.C 150 - 12A	12	150	180	557	172	240	49,0	PP	F5	M8B	5	900
D.C 200 - 12A	12	200	240	533	250	240	63,0	PP	F6	M8B	5	1200

## NORMAL RECHARGE



Batteries to be recharged in CC-CV mode only.

OPERATION MODE	VOLTAGE SETTING (12V, 20 - 30 °C)	CURRENT SETTING
FLOAT	13.7V +/- 0.1V	Maximum: 0.3CA Minimum: 0.1CA
CYCLIC	14.7V +/- 0.1V	

**CHARGING CHARACTERISTICS**

Temperature Compensation : (Reference 25°C)  
 Float Operation : -18mV/°C / Cyclic Operation : -30mV/°C (per 12V unit)

## FAST RECHARGE



During operation, if the battery bank is subjected to regular (daily) deep discharge in excess of 50% (cumulative basis), the fast recharge option may be exercised.

Fast recharge, following pattern to be followed:

- Step 1 : 0.3C - 14.5V
- Step 2 : 0.1C - 14.5V
- Step 3 : 0.05C - 14.5V
- Step 4 : 0.02C - 14.5V

Total duration for the four steps shall be 5.0 hours for a recharge after a 70% DOD. However, this mode of recharge will require an equalization once a month

## CYCLIC USE



1. Maintain a constant voltage charge at a voltage of 2.45 V/cell (25°C). When charging at an ambient temperature of 5°C or below or 35°C or above, it is necessary to adjust the charge voltage in relation with the temperature. The temperature coefficient should be -5mV°C/cell.
2. The maximum charge current should be 0.3CA or less.
3. To avoid overcharging on completion of charge, we recommend charging to be stopped or the constant voltage to be reduced to 2.275V/cell (25°C).
4. We also recommend charging the battery at an ambient temperature between 5 to 35°C to prevent any adverse effects on its effective life.
5. In case the battery has to be discharged deeply and frequently during use, to avoid poor charging, we recommend the charging time to be extended to as much as 1.5 to 2 times that of usual charging, once every five cycles of discharge & recharge.
6. If higher than recommended/faster charge is required, please consult us.

# PERFORMANCE CURVES

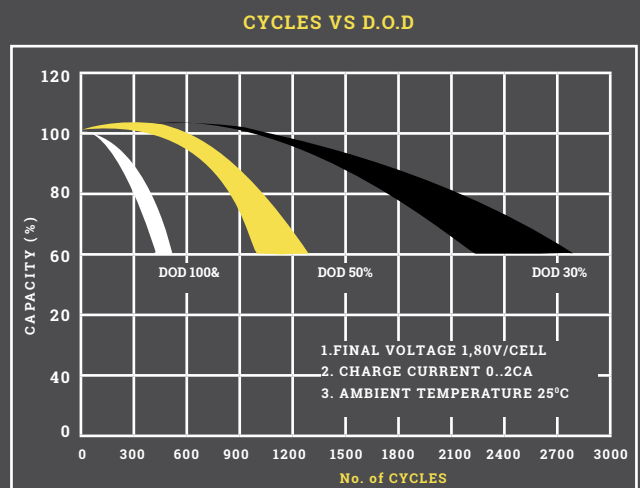
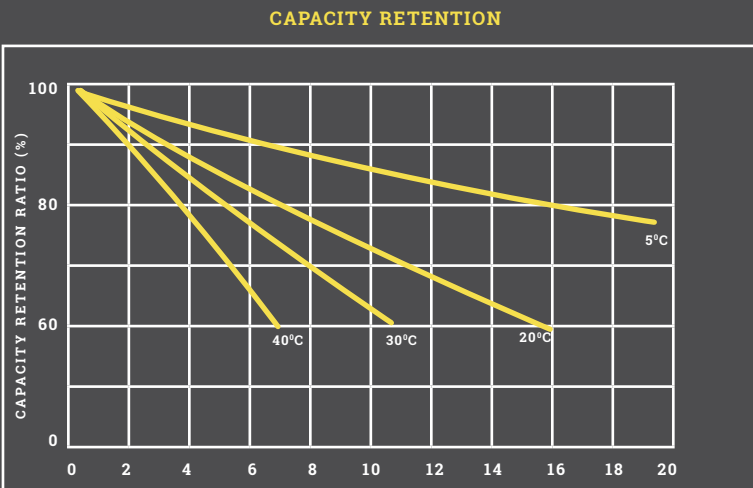
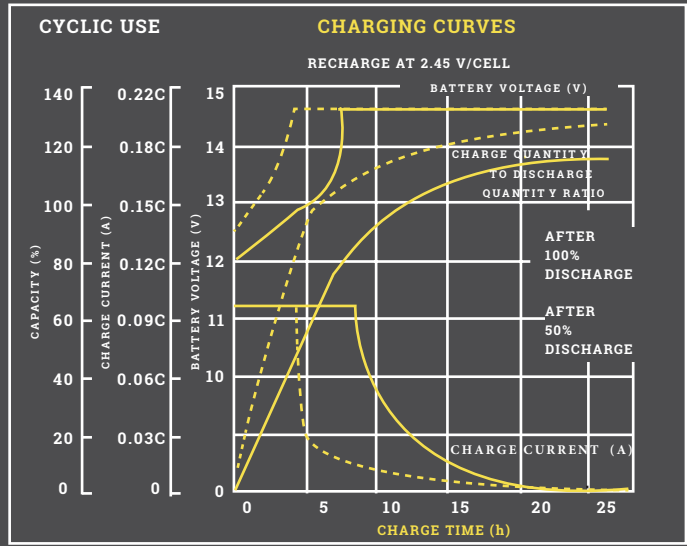
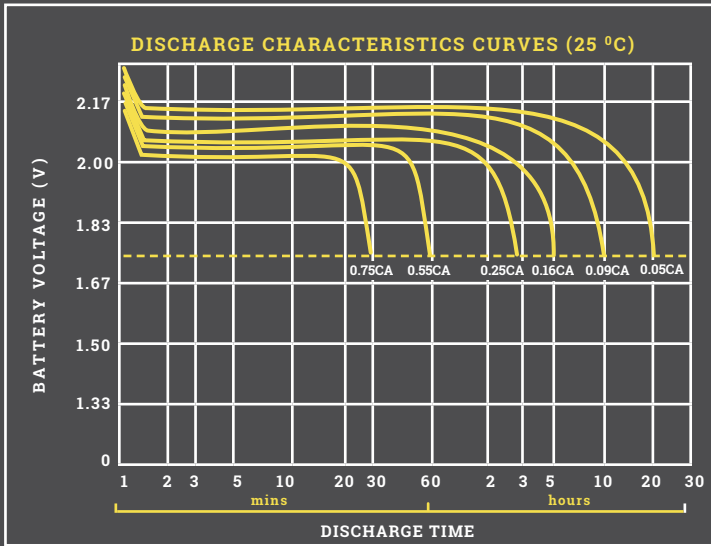

# BATTERY BANKS

In order to increase Battery Storage capacity, paralleling of Battery Strings is permitted under following conditions :

- ➔ Paralleling of a maximum of three strings is allowed provided they are all of the same brand, same age and Ah capacity.
- ➔ Adequate care shall be taken in ensuring that all inter-unit connecting cables have equal length and cross-section. All system cables from each of the strings, shall also be of same length and cross - section.
- ➔ Total charging current in the case of parallel strings, to be taken care of so that each of the strings get the recommended level of Amperes - minimum 10% and maximum 30% of the rated C20 capacity of each of the 12V blocks.

# TERMINAL TYPES - LAYOUTS

## BATTERY LAYOUT

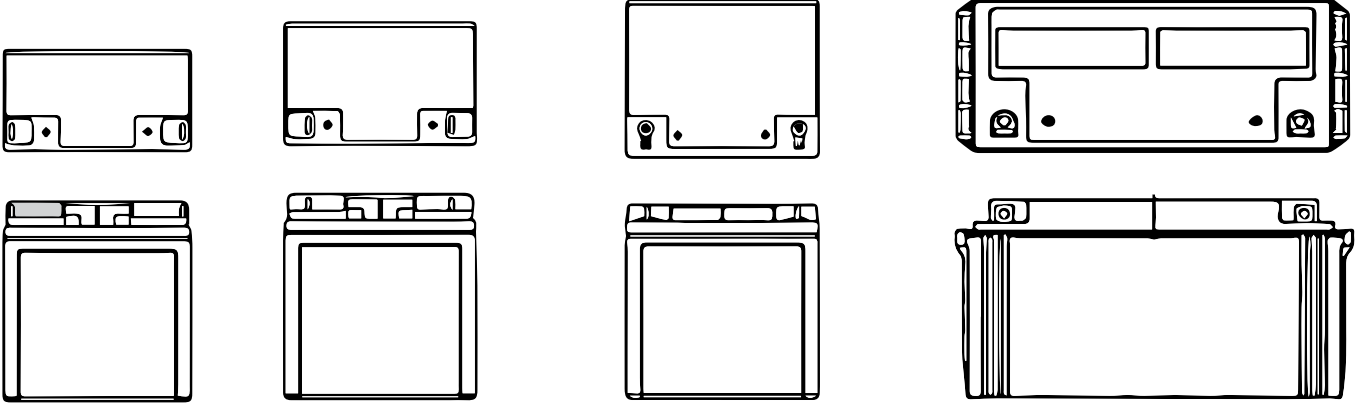

F1

F2

F3

F4

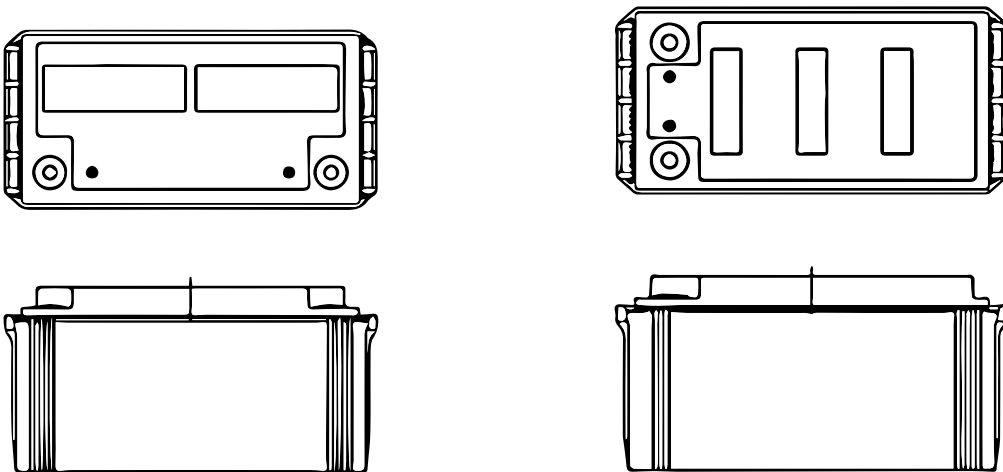

F5

F6

## BATTERY TERMINALS

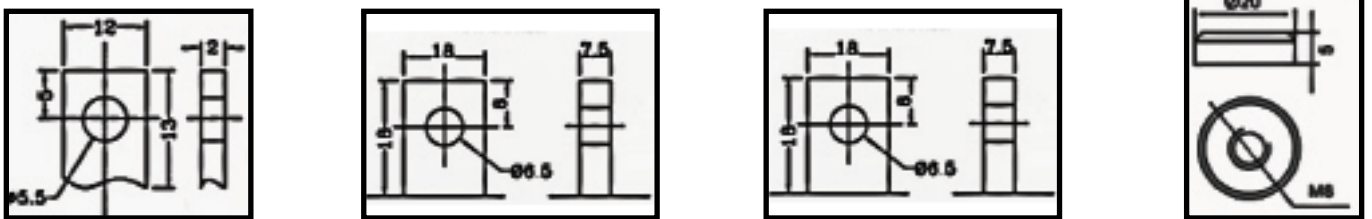

M5

M6

M8A

M8B

# NorthBa

Power for Life



## DEEP CYCLE AGM

### D.C VRLA AGM SERIES



HEADQUARTERS  
SCHOLIOU 6, IONIA,  
THESSALONIKI, GREECE  
PC: 57 008 PO BOX: 485  
T.: +30 2310 785722  
F.: +30 2310 760882



[info@northbatt.com](mailto:info@northbatt.com)



[www.northbatt.com](http://www.northbatt.com)