

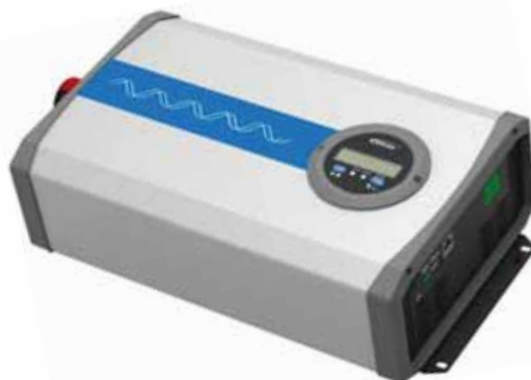

Pure sine wave inverter

USER MANUAL



Model

IP1000-Plus, IP1500-Plus

IP2000-Plus, IP3000-Plus

IP4000-Plus, IP5000-Plus

EN

Contents

Important safety instructions	1
1 Overview	5
2 Appearance	7
3 Naming rule	11
4 Connection diagram	12
5 Remote meter.....	14
5.1 Appearance	14
5.2 Status display	14
5.3 Buttons	15
5.4 LCD display interface	15
5.5 Settings	16
5.6 Error code	17
6 Installation	18
6.1 Attentions	18
6.2 Wire size and circuit breaker	18
6.3 Mounting	20
6.4 Rotate the LCD.....	26
7 Protections	27
8 Troubleshooting.....	31
9 Maintenance.....	32
10 Specifications	33
Appendix 1 Disclaimers.....	47

Important safety instructions

Please reserve this manual for future review.

This manual contains all safety, installation, and operation instructions for IPower- Plus series high-frequency pure sine wave inverter ("inverter" as referred to in this manual).

1. Explanation of symbols

To enable users to use the product efficiently and ensure personal and property safety, please read related literature accompanying the following symbols.

Please read the literature accompanying the following symbols.

 **Tips:** Indicate recommendations that can be referred to.

 **IMPORTANT:** Indicates a critical tip during the operation, if ignored, may cause the device to run in error.

 **CAUTION:** Indicates potential hazards, if not avoided, may cause the device damaged.

 **WARNING:** Indicates the danger of electric shock, if not avoided, it would cause casualties.

 **WARNING HOT SURFACE:** Indicates the risk of high temperature, if not avoided, would cause scalds.

 All of the safety and operating instructions should be read, adhered to and followed before operating the device.

 The entire system should be installed by professional and technical personnel.

2. Requirements for professional and technical personnel

- Professionally trained;
- Familiar with related safety specifications for the electrical system;
- Read this manual carefully and master related safety cautions.

3. Professional and technical personnel is allowed to do

- Install the inverter to a specified location.
- Conduct trial operations for the inverter.
- Operate and maintain the inverter.

4. Safety cautions before installation

- When you receive the inverter, check whether there is any damage that occurred in transportation. Contact the transportation company or our company in time for any problem.
- When place or move the inverter, must follow the instructions in the manual.
- When installing the inverter, you must evaluate whether the operation area exists any arc danger.
- The inverter needs to be connected to a battery. It is recommended that the minimum capacity (Ah) of the battery is five times the current that equals the rated output power of the inverter divided by the battery voltage.
- Keep the inverter out of reach of children.
- This inverter is an off-grid type. It is strictly prohibited to connect the inverter to the grid; otherwise, it will be damaged.
- This inverter is only allowed for stand-alone operation. It is prohibited to connect multiple units' in parallel or series; otherwise, the inverter will be damaged.

5. Safety cautions for mechanical installation

- Before installation, make sure the inverter has no electrical connection.
- Ensure enough heat dissipation space for the inverter before installation. Do not install the inverter in a harsh environment such as humid, greasy, flammable, explosive, or dust accumulation.

6. Safety cautions for electrical connection

- Check whether all the wiring connections are tight to avoid the danger of heat accumulation due to loose connections.
- The protective grounding must be connected to the ground. The cross-section of the wire should not be less than 4mm²
- The DC input voltage must strictly be following the parameter table. Too high or too low DC input voltage will affect the inverter's normal operation and may even damage it.
- It is recommended that the length of the connection between the battery and the inverter be less than 3 meters. If greater than 3 meters, please reduce the current

density of the connection wire.

- A fuse or breaker should be used between battery and inverter; the fuse or breaker's rated current should be twice the inverter rated input current.
- DO NOT install the inverter close to the flooded lead-acid battery because the terminals' sparkle may ignite the hydrogen released by the battery.
- The AC output terminal is only for the load connection. Do NOT connect it to other power sources or utility; otherwise, the inverter will be damaged. Turn off the inverter when connecting loads.
- Do not connect battery chargers or other similar products to the inverter's input terminal; otherwise, the inverter will be damaged.

7. Safety cautions for controller operation

- When the inverter is working, the shell will generate a lot of heat. The temperature is very high; please do not touch it.
- When the inverter is running, please do not open the cabinet.
- The AC output of the inverter is of high voltage, do not touch the wiring connection to avoid electric shock.

8. Dangerous operations which would cause electric arc, fire or explosion

- Touch the wire end that hasn't been insulation treated and maybe electriferous.
- Touch the wiring copper row, terminals, or internal modules of the inverter that may be electriferous.
- The connection of the power cable is loose.
- Screw or other spare parts inadvertently falls into the inverter.
- Improper operations by untrained non-professional or technical personnel.



Once an accident occurs, it must be handled by professional and technical personnel. Improper operations would cause more serious accidents.

9. Safety cautions for stopping the inverter

- After the inverter stop running for five minutes, the internal conductive modules could be touched.
- The inverter is allowed to restart after removing the faults, which affects safety performance.
- There are no serviceable parts inside. If any maintenance service is required, please contact our service personnel.



Do NOT touch or open the shell after the inverter is powered off within ten minutes.

10. Safety cautions for inverter maintenance

- It is recommended to check the inverter with testing equipment to ensure there is no voltage and current.
- When conducting electrical connection and maintenance, post a temporary warning sign or put up barriers to prevent unrelated personnel from entering the electrical connection or maintenance area.
- An improper operation of the inverter may cause personal injury or equipment damage.
- To prevent static damage, please wear an anti-static wrist strap, or avoid unnecessary contact with the circuit board.

1 Overview

IPower-Plus is a new generation of pure sine wave inverter compatible with the lithium battery system. This new inverter adopts surge current suppression technology to effectively prevent the surge current from damaging the lithium battery cells and BMS (Battery Management System). Also, adopting the voltage and current double closed-loop control algorithm brings the inverter a faster response and better resistance to the load impact. The inverter selects key components with a high power density and long lifespan to provide a stable and reliable power guarantee. The optional communication solutions allow users to monitor the real-time status or change the parameters wherever. The inverter can be widely used in DC to AC areas, such as solar AC power system, vehicle system, RV power supply, security monitoring system, emergency lighting system, field power system, household power system, etc. With an excellent EMC (Electro Magnetic Compatibility) characteristic, the inverter is also suitable for occasions with high power quality requirements.

Features:

- Completely electrically isolated design for input and output
- Full digital double closed-loop control
- Excellent EMC characteristic, widely applied to higher quality power system
- Advanced SPWM technology and pure sine wave output.
- Input surge current suppression technology, applying to the lithium battery system
- Outstanding load resistance to impact, applying to the air conditioners, washing machines, refrigerators, etc.
- High power density and high-quality components to ensure the reliability
- Output power factor up to 1
- Low loss of zero loads and standby. Low THD (Total Harmonic Distortion). High conversion efficiency

- Extensive protections: input reverse polarity/under voltage/over voltage, output overload/short circuit/overheating
- Air cooling controlled by temperature and load
- Rotatable LCD meter to simplify the system wiring
- Friendly LCD meter to simply monitor and parameter configure
- Remote control by the phone Apps and PC software
- Configurable output voltage and output frequency①
- Charging mobile phones, DC fans, and other electrical equipment by the USB port②
- Support a variety of options by connecting with the RS485 com. port③
- External switch contact design to allow remote control
- IEC62109, EN61000, RoHS approved

① **Configuring the parameters via the local LCD meter, remote LCD meter, phone Apps, and PC software.**

② **This function is unavailable for inverters with 48V input voltage.**

③ **There is no communication isolation design for inverters with 12V/24 input voltage. This function(communication isolation design) is just for inverters with 48V input voltage.**

2 Appearance

- IP1000-xx-Plus

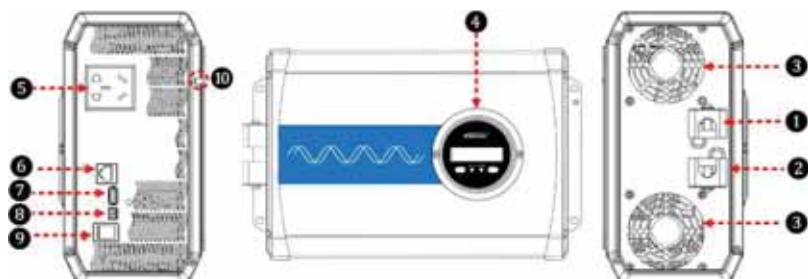

- IP1500-xx/IP2000-2x/IP2000-4x/IP3000-42-Plus

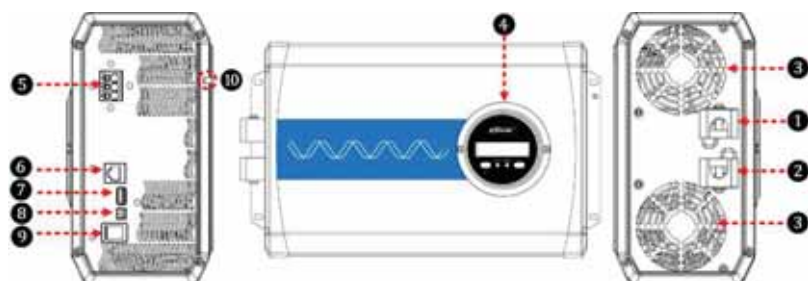

- IP2000-1x-Plus

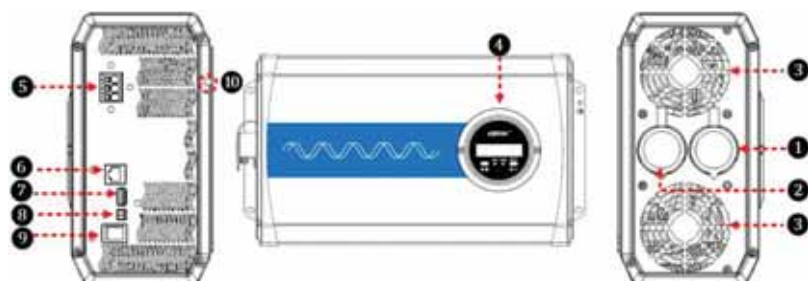

- IP3000-1x-Plus

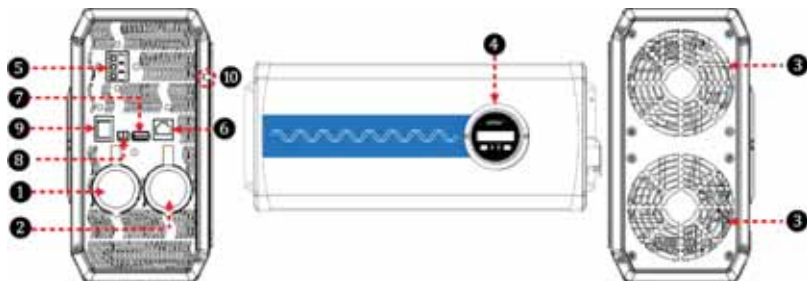

- IP3000-2x-Plus

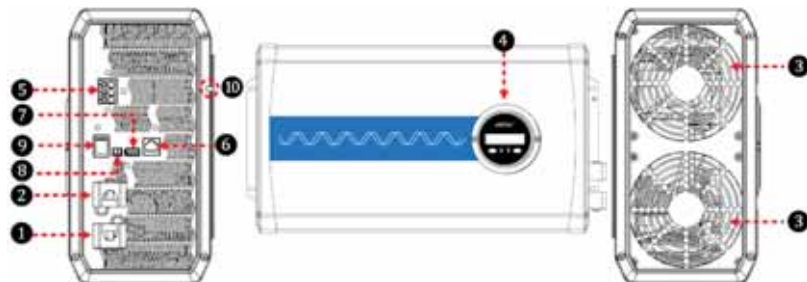

- IP3000-41/IP4000-4x/IP5000-4x-Plus

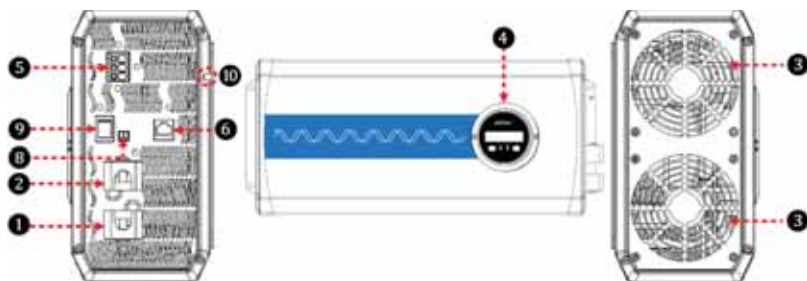

①	DC input terminal positive	⑥	RS485 communication port
②	DC input terminal negative	⑦	USB output port 5VDC/Max.1A [®]
③	Cooling fan [®]	⑧	External switch port
④	LCD	⑨	Inverter switch
⑤	AC outlet [®]	⑩	Grounding terminal

① **Cooling fan**

• **Conditions to start the cooling fan:**

Heat sink temperature is higher than 45°C or The internal inverter temperature is higher than 45°C or The output power is higher than 700W	IP1500-11-Plus(T)
	IP1500-12-Plus(T)
	IP1500-21-Plus(T)
	IP1500-22-Plus(T)
	IP1500-41-Plus(T)
	IP1500-42-Plus(T)
Heat sink temperature is higher than 45°C or The internal inverter temperature is higher than 45°C or The output power is higher than 50% of the rated power	IP1000-11-Plus(T/N)
	IP1000-12-Plus(A/E/C/T)
	IP1000-21-Plus(T/N)
	IP1000-22-Plus(A/E/C/T)
	IP2000-11-Plus(T)
	IP2000-12-Plus(T)
	IP2000-21-Plus(T)
	IP2000-22-Plus(T)
	IP2000-41-Plus(T)
	IP2000-42-Plus(T)
	IP3000-11-Plus(T)
	IP3000-12-Plus(T)
	IP3000-21-Plus(T)
	IP3000-22-Plus(T)
	IP3000-41-Plus(T)
	IP3000-42-Plus(T)
IP4000-41-Plus(T)	
IP4000-42-Plus(T)	
IP5000-42-Plus(T)	

Symbols of A/E/C/N/T mean different AC outlets: A-Australia/New Zealand, E-European, C-Chinese dual socket, N-North America, and T-Terminal.

• **Conditions to stop the cooling fan:**

Heat sink temperature is lower than 40°C and	IP1000-11-Plus(T/N)
--	---------------------

The internal inverter temperature is lower than 40°C and The output power is lower than 300W	IP1000-12-Plus(A/E/C/T)
	IP1000-21-Plus(T/N)
	IP1000-22-Plus(A/E/C/T)
Heat sink temperature is lower than 40°C and The internal inverter temperature is lower than 40°C and The output power is lower than 500W	IP1500-11-Plus(T)
	IP1500-12-Plus(T)
	IP1500-21-Plus(T)
	IP1500-22-Plus(T)
	IP1500-41-Plus(T)
	IP1500-42-Plus(T)
Heat sink temperature is lower than 40°C and The internal inverter temperature is lower than 40°C and The output power is lower than 40% of the rated power	IP2000-11-Plus(T)
	IP2000-12-Plus(T)
	IP2000-21-Plus(T)
	IP2000-22-Plus(T)
	IP2000-41-Plus(T)
	IP2000-42-Plus(T)
	IP3000-11-Plus(T)
	IP3000-12-Plus(T)
	IP3000-21-Plus(T)
	IP3000-22-Plus(T)
	IP3000-41-Plus(T)
	IP3000-42-Plus(T)
	IP4000-41-Plus(T)
	IP4000-42-Plus(T)
IP5000-42-Plus(T)	

Symbols of A/E/C/N/T mean different AC outlets: A-Australia/New Zealand, E-European, C-Chinese dual socket, N-North America, and T-Terminal.

② AC outlet types include A-Australia/New Zealand, E-European, C-Chinese dual socket, N-North America, M-Universal and T-Terminal. Different inverter may has different AC outlet.

③ USB output port is not available for inverters with 48V input voltage.

3 Naming rule

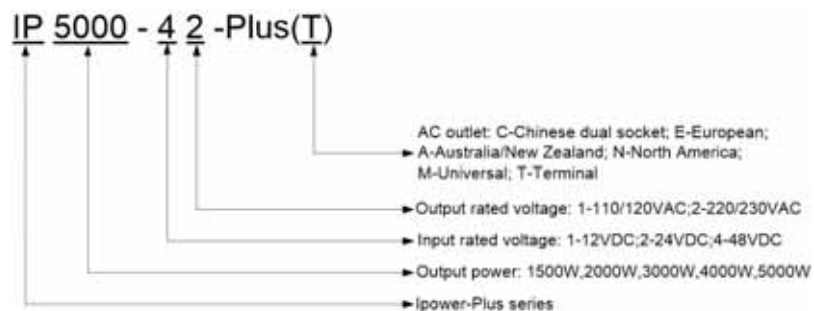

4 Connection diagram

- IP1000-xx/IP1500-xx/IP2000-2x/IP2000-4x/IP3000-42-Plus

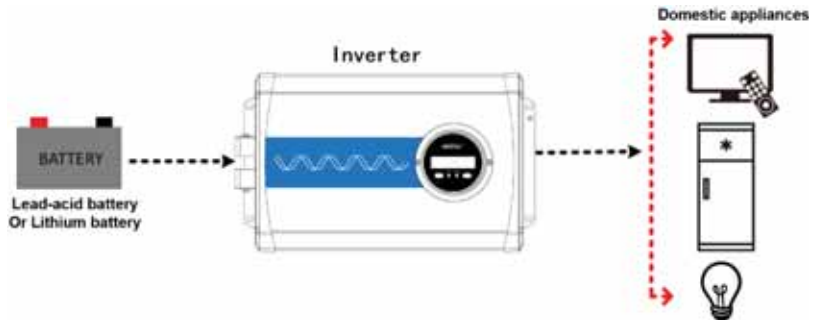

- IP2000-1x-Plus

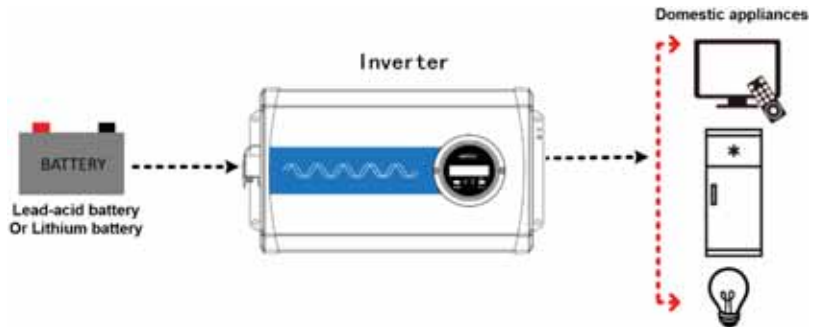

➤ IP3000-1x-Plus

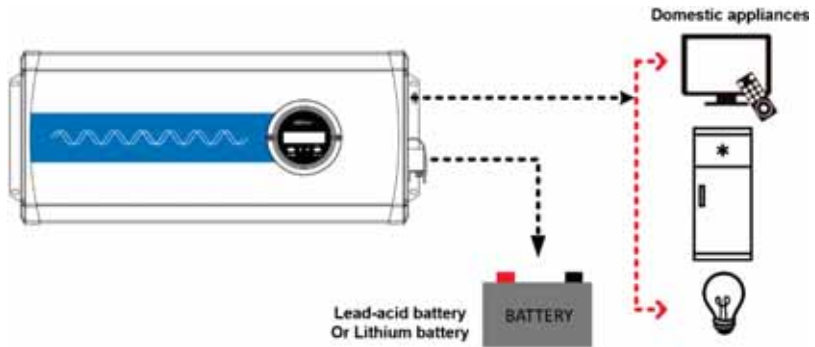

➤ IP3000-2x/IP3000-41/IP4000-4x/IP5000-4x-Plus

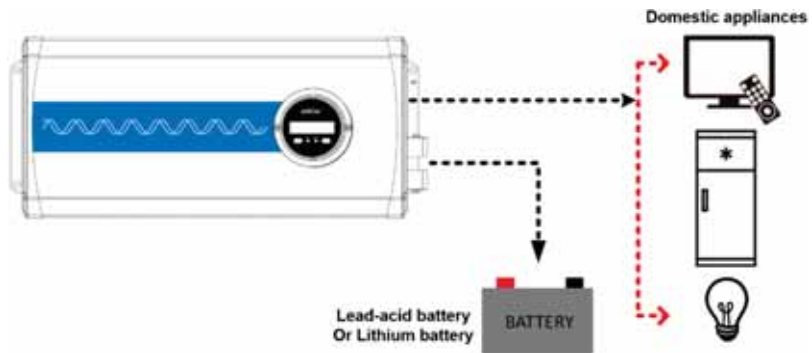

It is recommended to connect the inverter DC input terminal to the battery terminal directly. DO NOT connect it to the charge source terminal. Otherwise, the charging voltage spikes of the charge source may cause over-voltage protection of the inverter.

5 Remote meter

5.1 Appearance







①	LCD	④	Working status indicator(Blue)
②	UP/Setting button	⑤	DOWN/Enter button Output ON/OFF button
③	Fault indicator(red)	⑥	Fixing screws

5.2 Status display

Working status indicator	Fault indicator	Buzzer	Status
Blue ON solid	Red OFF	No beeps	Output voltage normal
Blue slowly flashing(1/4Hz)	Red OFF	Buzzer beeps	Input under voltage
Blue fast flashing (1Hz)	Red OFF	Buzzer beeps	Input over voltage
Blue OFF	Red ON solid	Buzzer beeps	Inverter over temperature

			Heat sink over temperature
Blue OFF	Red fast flashing (1Hz)	Buzzer beeps	Load short circuit
Blue ON solid	Red slowly flashing(1/4Hz)	Buzzer beeps	Overload
Blue OFF	Red OFF	Buzzer beeps	Output voltage abnormal



5.3 Buttons

	Click	Move up
	Press for 2s	In the real-time interface, press it for 2s to enter the setting interface. In the setting interface, press it for 2s to enter the parameters configuration interface.
	Click	Move down
	Press for 2s	In the real-time interface, press it to turn on/off the load output (default on, press it for 2s to turn off.) Confirm the settings
 + 	Click	In the setting interface, click them to exit the parameters configuration interface.
	Press for 2s	In the real-time interface, press them for 2s to clear the faults.



The long buzzer beeps for the parameter confirming, and short beeps for other button operations.



5.4 LCD display interface

Click  or  to browse the real-time interface.



5.5 Settings

Operation:



Step1: In the real-time interface, press  for 2s to enter the setting interface.

Step2: Click  or  to select the parameter to be configured.

Step3: Press  for 2s to enter the configuration interface of the specified parameter.

Step4: Click  or  to configure the parameter value.

Step5: Press  for 2s to confirm the configuration.

Step6: Click  +  to exit the current interface.

Display	Parameters	Default	User define
⚙️ VPT	Output voltage class [®]	220VAC	220VAC/ 230Vac
		110VAC	110VAC/ 120VAC
⚙️ FRE	Output frequency class [®]	50Hz	50Hz/60Hz
⚙️ BLT	LCD backlight time	30s	30s/ 60s/100s(ON solid)
⚙️ LVD	Low voltage disconnect voltage [®]	12V: 10.8V	12V: 10.5V~14.2V; step size 0.1V
		24V: 21.6V	24V: 21V-30.2V; step size 0.1V
		48V: 43.2V	48V: 42V-62.4V; step size 0.1V
⚙️ LVR	Low voltage reconnect voltage [®]	12V: 12.5V	12V: 11.5V~15.2V; step size 0.1V
		24V: 25V	24V: 22V-31.2V; step size 0.1V
		48V: 50V	48V: 43V-63.4V; step size 0.1V
⚙️ OVR	Over voltage reconnect voltage [®]	12V: 14.5V	12V: 11.5V~15.2V; step size 0.1V
		24V: 29V	24V: 22V-31.2V; step size 0.1V
		48V: 58V	48V: 43V-63.4V; step size 0.1V
⚙️ OVD	Over voltage disconnect voltage [®]	12V: 16V	12V: 12.5V~16.2V; step size 0.1V
		24V: 32V	24V: 23V-32.2V; step size 0.1V
		48V: 64V	48V: 44V-64.4V; step size 0.1V

- ① After configuring the parameters marked with ①, the inverter will restart automatically. It will resume work according to the new parameter value.
- ② For the parameter user define, please refer to the input voltage rules in Chapter 7 [Protections](#). Otherwise, the parameter setting will not succeed.

5.6 Error code

Error code	Faults	Buzzer
△OTP	Inverter over temperature Heat sink over temperature	Five beeps
△IOV	Input over voltage	
△ILV	Input low voltage	
△OSC	Output short circuit	
△OOL	Output overload	
△OVA	Output voltage abnormal	

6 Installation

6.1 Attentions

- Read all the installation instructions carefully in the manual before installation.
- Be very careful when installing the batteries. Please wear eye protection when installing the open-type lead-acid battery, and rinse with clean water in time for battery acid contact.
- Keep the battery away from any metal objects, which may cause a short circuit of the battery.
- Loose power connections and corroded wires may result in high heat that can melt wire insulation, burn surrounding materials, or even cause a fire. Ensure tight connections and secure cables with clamps to prevent them from swaying while moving the inverter.
- The DC input voltage must strictly be following the parameter table. Too high or too low DC input voltage will affect the inverter's normal operation and even damage it. The surge voltage shall be less than 20V for the 12V system, and less than 40V for the 24V system, and less than 80V for the 48V system.
- Select the connection cables according to the current density of 3.5A/mm² or less.
- Avoid direct sunlight and rain infiltration when installing it outdoor.
- After turn off the power switch, do not open or touch the internal component immediately. Performing related operations after 10 minutes is recommended.
- Do not install the inverter in a harsh environment such as humid, greasy, flammable, explosive, or dust accumulation.
- The AC output is of high voltage, do not touch the wiring connection to avoid electric shock.
- To prevent injury, do not touch the fan while it is working.

6.2 Wire size and circuit breaker

The wiring and installation methods must conform to the national and local electrical code requirements.

➤ **Wire, terminals, and circuit breaker selection for battery**

Models	Battery wire size	Ring terminal	Circuit breaker
IP1000-11-Plus(T/N)	25mm ² /1AWG	RNB38-6	DC/2P-125A
IP1000-12-Plus(A/E/C/T)	25mm ² /1AWG	RNB38-6	DC/2P-125A
IP1000-21-Plus(T/N)	16mm ² /5AWG	RNB14-6S	DC/2P-63A
IP1000-22-Plus(A/E/C/T)	16mm ² /5AWG	RNB14-6S	DC/2P-63A
IP1500-11-Plus(T)	25mm ² /3AWG*2	RNB60-6	DC-100A(2P in parallel)
IP1500-12-Plus(T)	25mm ² /3AWG*2	RNB60-6	DC-100A(2P in parallel)
IP1500-21-Plus(T)	16mm ² /5AWG	RNB14-6S	DC/2P-125A
IP1500-22-Plus(T)	16mm ² /5AWG	RNB14-6S	DC/2P-125A
IP1500-41-Plus(T)	10mm ² /8AWG	RNB14-6S	DC/2P-63A
IP1500-42-Plus(T)	10mm ² /8AWG	RNB14-6S	DC/2P-63A
IP2000-11-Plus(T)	35mm ² /1AWG*2	RNB70-10	DC-125A(2P in parallel)
IP2000-12-Plus(T)	35mm ² /1AWG*2	RNB70-10	DC-125A(2P in parallel)
IP2000-21-Plus(T)	35mm ² /1AWG	RNB38-6	DC/2P-125A
IP2000-22-Plus(T)	35mm ² /1AWG	RNB38-6	DC/2P-125A
IP2000-41-Plus(T)	16mm ² /5AWG	RNB14-6S	DC/2P-63A
IP2000-42-Plus(T)	16mm ² /5AWG	RNB14-6S	DC/2P-63A
IP3000-11-Plus(T)	25mm ² /3AWG*4	RNB80-10	DC-125A(3P in parallel)
IP3000-12-Plus(T)	25mm ² /3AWG*4	RNB80-10	DC-125A(3P in parallel)
IP3000-21-Plus(T)	25mm ² /3AWG*2	RNB60-6	DC-100A(2P in parallel)
IP3000-22-Plus(T)	25mm ² /3AWG*2	RNB60-6	DC-100A(2P in parallel)
IP3000-41-Plus(T)	25mm ² /3AWG	RNB22-6S	DC/2P-125A
IP3000-42-Plus(T)	25mm ² /3AWG	RNB22-6S	DC/2P-125A
IP4000-41-Plus(T)	35mm ² /1AWG	RNB38-6	DC/2P-125A
IP4000-42-Plus(T)	35mm ² /1AWG	RNB38-6	DC/2P-125A
IP5000-42-Plus(T)	25mm ² /3AWG*2	RNB60-6	DC-100A(2P in parallel)

Note: The above wire size and circuit breaker size are for reference only; please choose a suitable wire and circuit breaker according to the actual situation.

➤ **Wire and circuit breaker selection for AC output**

Models	Wire size	Circuit breaker
IP1000-11-Plus(T/N)	2.5mm ² /13AWG	AC/2P-16A
IP1000-12-Plus(A/E/C/T)	1.5mm ² /15AWG	AC/2P-10A

IP1000-21-Plus(T/N)	2.5mm ² /13AWG	AC/2P-16A
IP1000-22-Plus(A/E/C/T)	1.5mm ² /15AWG	AC/2P-10A
IP1500-11-Plus(T)	4mm ² /11AWG	AC/2P-25A
IP1500-12-Plus(T)	1.5mm ² /15AWG	AC/2P-10A
IP1500-21-Plus(T)	2.5mm ² /13AWG	AC/2P-25A
IP1500-22-Plus(T)	1.5mm ² /15AWG	AC/2P-10A
IP1500-41-Plus(T)	2.5mm ² /13AWG	AC/2P-25A
IP1500-42-Plus(T)	1.5mm ² /15AWG	AC/2P-10A
IP2000-11-Plus(T)	4mm ² /11AWG	AC/2P-32A
IP2000-12-Plus(T)	2.5mm ² /13AWG	AC/2P-16A
IP2000-21-Plus(T)	4mm ² /11AWG	AC/2P-32A
IP2000-22-Plus(T)	2.5mm ² /13AWG	AC/2P-16A
IP2000-41-Plus(T)	4mm ² /11AWG	AC/2P-32A
IP2000-42-Plus(T)	2.5mm ² /13AWG	AC/2P-16A
IP3000-11-Plus(T)	6mm ² /10AWG	AC/2P-50A
IP3000-12-Plus(T)	4mm ² /11AWG	AC/2P-25A
IP3000-21-Plus(T)	6mm ² /10AWG	AC/2P-50A
IP3000-22-Plus(T)	4mm ² /11AWG	AC/2P-25A
IP3000-41-Plus(T)	6mm ² /10AWG	AC/2P-50A
IP3000-42-Plus(T)	4mm ² /11AWG	AC/2P-25A
IP4000-41-Plus(T)	6mm ² /10AWG	AC/2P-63A
IP4000-42-Plus(T)	4mm ² /11AWG	AC/2P-32A
IP5000-42-Plus(T)	4mm ² /11AWG	AC/2P-40A

Note: The above wire size and circuit breaker size are for reference only; please choose a suitable wire and circuit breaker according to the actual situation.



- The wire size is only for reference. Suppose there is a long distance between the inverter and the battery. In that case, larger wires shall be used to reduce the voltage drop and improve system performance.
- The above wire size and circuit breaker size are for reference only; please choose a suitable wire and circuit breaker according to the actual situation.

6.3 Mounting

Installation procedures:

Step1: Professional personnel reads this manual carefully.

Step 2: Determine the installation location and heat-dissipation space

To ensure natural thermal convection, you should install the inverter in a place with sufficient air-flow and a minimum clearance of 150mm from the inverter's upper and lower edges.



Ventilation is highly recommended if mounted in an enclosure.

➤ **IP1000-xx/IP1500-xx/IP2000-2x/IP2000-4x/IP3000-42-Plus**



➤ **IP2000-1x-Plus**



➤ **IP3000-1x-Plus**



➤ **IP3000-2x/IP3000-41/IP4000-4x/IP5000-4x-Plus**



Step3: Wiring



The AC loads shall be determined by the continuous output power of the inverter. The AC load's surge power must be lower than the instantaneous surge power of the inverter, or the inverter will be damaged.



- Set the inverter switch to OFF status before wiring.
- During wiring, do not close the circuit breaker or fuse. Ensure the leads of "+" and "-" poles are polarity correctly.
- A fuse whose current is 2 to 2.5 times the inverter's rated current must be installed on the battery end. Distance between them is not more than 150mm.
- The positions of the terminals and ports on the side vary from inverter models.

Wiring sequence (The following wiring sequence is illustrated in the appearance "IP2000-2x-Plus", wiring positions of other inverters please refer to chapter [2 Appearance](#) for reference.)

① Ground line

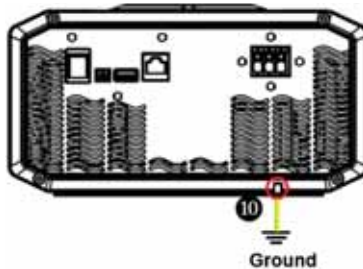

② Battery

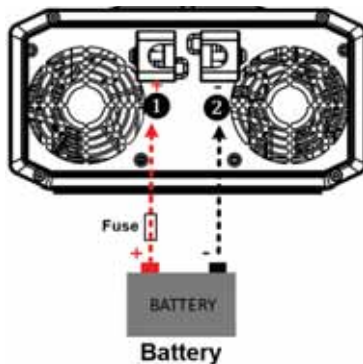

③ AC loads

1) Definition of the AC output terminal



- ✦ It is recommended to use a multi-stranded wire with a wire diameter of not more than 4mm².
- ✦ Add solder to the connection point when selecting the multi-stranded wire, and directly insert it into the corresponding port.

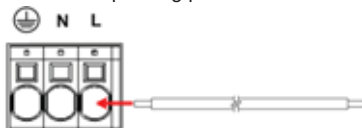

- ✦ Stop the inverter before removing the wiring. Then, insert a sharp tool into the small hole (on the top of the port) and pull out the wiring forcefully.

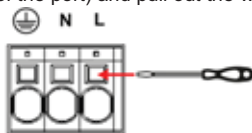

2) Connect the AC load

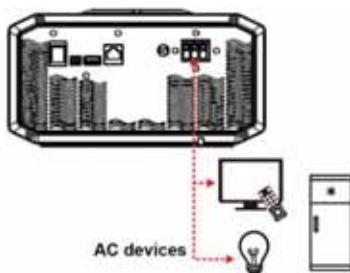

④ Optional accessories

1) RS485 communication port



RJ45 Pin Definition:

Pin	Definition	Pin	Definition
1	5VDC	5	RS-485-A
2	5VDC	6	RS-485-A
3	RS-485-B	7	GND
4	RS-485-B	8	GND

2) Connect optional accessories

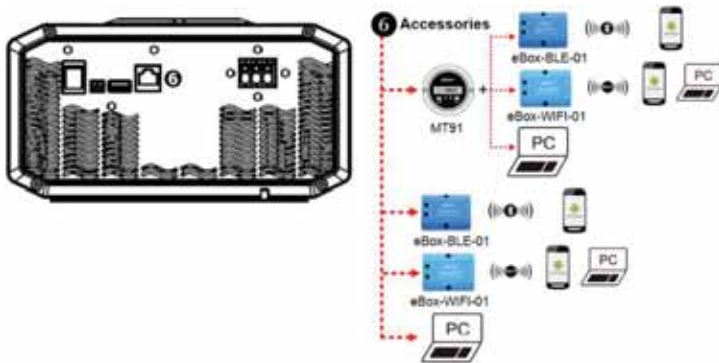

5) USB port (USB port is not available for inverters with 48V input voltage.)

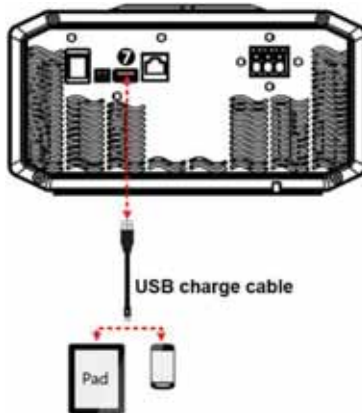

Step 4: Power on the inverter

- (1) Switch on the breaker at the inverter input terminal or the fuse at the battery end.
- (2) Turn on the inverter switch; the blue indicator will be lighted on, which states a normal AC output.
- (3) Turn on the AC loads one by one and check the inverter's running status and the loads.



When supplying power for different loads, it is recommended to turn on the load with a large impulse current. And then turn on the load with a smaller impulse current after the load output is stable.

-
- (4) If the fault indicator flashes red and the buzzer alarms after powering on the inverter, please immediately turn off the load and the inverter. Clear the faults according to [Chapter 8 Troubleshooting](#).

6.4 Rotate the LCD

- (1) Remove the screws of the LCD unit with a screwdriver, and rotate it 180°.

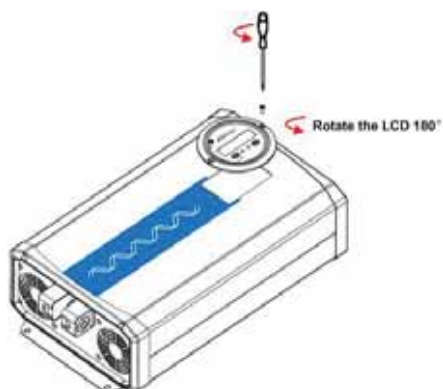

- (2) Secure the screws of the LCD unit to the inverter.

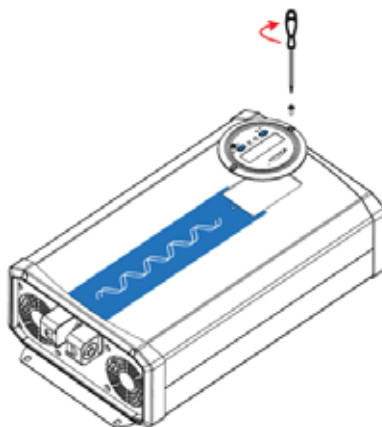

7 Protections

1) Input reverse polarity protection

When the DC input terminal's polarity is reversed, the indicator will not light up after power on, the buzzer will not sound, and the inverter will not work. The inverter will start to work normally after correcting the mis-wiring.





2) Input voltage protection

- **The following rules must be followed when modifying the battery's input voltage parameters:**
 - A. Over voltage limiting voltage(16.2/32.2/64.4V) \geq Over voltage disconnect voltage \geq Over voltage reconnect voltage +1V.
 - B. Over voltage reconnect voltage \geq Low voltage reconnect voltage.
 - C. Low voltage reconnect voltage \geq Low voltage disconnect voltage +1V.
 - D. Low voltage disconnect voltage \geq Low voltage limiting voltage(10.5/21/42V).
- **Detail status is shown as the following when the input voltage protection occurs.**

Input voltage protection	Status
Over voltage protection	The output is switched OFF. The blue indicator fast flashes. Buzzer beeps. LCD displays the ΔIOV
Over voltage reconnect	The blue indicator is ON solid. The output voltage is normal.
Low voltage protection	The output is switched OFF. The blue indicator slowly flashes. Buzzer beeps. LCD displays the ΔILV
Low voltage reconnect	The blue indicator is ON solid. The output voltage is normal.





Note: Although the inverter is supplied with the over voltage protection, the surge voltage is not higher than 20V for the 12V system, not higher than 40V for the 24V system, and not higher than 80V for the 48V system; otherwise, the inverter may be damaged.

3) Overload protection

<p>IP1000-11-Plus IP1000-12-Plus IP1000-21-Plus IP1000-22-Plus</p>	<p>$S=1.2P_e$ (S: Output power; P_e: Rated power)</p>	<p>The output is switched OFF after 1 minute. Buzzer beeps. The red indicator slowly flashes. LCD displays the .</p>
<p>IP1500-11-Plus IP1500-12-Plus IP1500-21-Plus IP1500-22-Plus IP1500-41-Plus IP1500-42-Plus</p>	<p>$S=1.5P_e$ (S: Output power; P_e: Rated power)</p>	<p>The output is switched OFF after 30 seconds. Buzzer beeps. The red indicator slowly flashes. LCD displays the .</p>
<p>IP2000-11-Plus★ IP2000-12-Plus IP2000-21-Plus IP2000-22-Plus IP2000-41-Plus IP2000-42-Plus</p>	<p>$S=1.8P_e$ (S: Output power; P_e: Rated power)</p>	<p>The output is switched OFF after 10 seconds. Buzzer beeps. The red indicator slowly flashes. LCD displays the .</p>
<p>IP3000-21-Plus★ IP3000-22-Plus IP3000-41-Plus IP3000-42-Plus</p>	<p>$S>2P_e$(Rated input voltage) (S: Output power; P_e: Rated power)</p>	<p>The output is switched OFF after 5 seconds. Buzzer beeps. The red indicator slowly flashes. LCD displays the .</p>

Note: When the overload protection happens, the AC output is recovered automatically three times (recover after 5s, 10s, 15s separately). After three times the recovery attempt failed, you need to restart the inverter to recover the AC output.

★ When the overload protection happens on IP2000-11-Plus or IP3000-21-Plus, the AC output is shut down directly and cannot be recovered automatically.

IP3000-11-Plus IP3000-12-Plus IP4000-41-Plus IP4000-42-Plus	$S=1.2P_e$ (S: Output power; P_e : Rated power)	The output is switched OFF after 1 minute. Buzzer beeps. The red indicator slowly flashes. LCD displays the  .
	$S=1.7P_e$ (S: Output power; P_e : Rated power)	The output is switched OFF after 10 seconds. Buzzer beeps. The red indicator slowly flashes. LCD displays the  .
	$S>1.7P_e(\text{Rated input voltage})$ (S: Output power; P_e : Rated power)	The output is switched OFF after 5 seconds. Buzzer beeps. The red indicator slowly flashes. LCD displays the  .
IP5000-42-Plus	$S=1.2P_e$ (S: Output power; P_e : Rated power)	The output is switched OFF after 1 minute. Buzzer beeps. The red indicator slowly flashes. LCD displays the  .
	$S=1.4P_e$ (S: Output power; P_e : Rated power)	The output is switched OFF after 10 seconds. Buzzer beeps. The red indicator slowly flashes. LCD displays the  .
	$S>1.4P_e(\text{Rated input voltage})$ (S: Output power; P_e : Rated power)	The output is switched OFF after 5 seconds. Buzzer beeps. The red indicator slowly

		flashes. LCD displays the 
--	--	--

Note: When the overload protection happens, the AC output cannot recover automatically. The AC output is shut down according to the multiple of the overload. Recovering the AC output after clearing the overload faults and restarting the inverter.

4) Output short circuit protection

Faults	Instruction
The output is switched OFF immediately. Buzzer beeps. Red indicators fast flashes. LCD displays the  .	Note: When the short circuit protection happens, the AC output is recovered automatically three times(recover after 5s, 10s, 15s separately). After three times the recovery attempt failed, you need to restart the inverter to recover the AC output.

5) Inverter over temperature protection

Faults	Instruction
LCD displays the  .	The inverter will stop working after the heat sink's temperature, or the internal modules go higher than a set value.
The inverter resumes work.	The inverter will resume work after the heat sink's temperature or the internal modules cools lower than a set value.

8 Troubleshooting



A high voltage will occur inside the inverter. DO NOT try to repair or maintain the inverter by yourself; it may cause an electric shock.

LCD	Faults	Reasons	Troubleshooting
	The blue indicator slowly flashes. Buzzer beeps.	The DC input voltage is too low.	Check whether the DC input voltage is lower than 10.8/21.6/43.2V by a multimeter. The inverter will resume work after adjusting the input voltage.
	Blue indicator fast flashes. Buzzer beeps.	The DC input voltage is too high.	Check whether the DC input voltage is higher than 16/32/64V by a multimeter. The inverter will resume work after adjusting the input voltage.
	The red indicator slowly flashes. Buzzer beeps.	Overload	Reduce the number of the AC load, and restart the inverter.
	Red indicators fast flashes. Buzzer beeps.	Output short circuit	Check the loads' connection carefully. Clear the short circuit faults and restart the inverter.
	Blue and red indicators are ON solid. Buzzer beeps.	Inverter over temperature	Improving the ventilation situation and cooling the surroundings' temperature, it is recommended to restart the inverter after the temperature drops. If the fault cannot be cleared after performing the above operations, decline the rated power for usage.

9 Maintenance

The following inspections and maintenance tasks are recommended at least two times per year for the best performance.

- Make sure no block on air-flow around the inverter. Clear up any dirt and fragments on the heat sink.
- Check all the naked wires to ensure the insulation is not damaged for serious solarization, frictional wear, dryness, insects or rats, etc. Repair or replace some wires if necessary.
- Check and confirm that the LED or LCD is consistent with the actual operation. Pay attention to any troubleshooting or error indications. Take corrective action if necessary.
- Check all the terminals for signs of corrosion, insulation damage, high temperature or burning/discoloration, and tighten the terminal screws.
- Clear up dirt, nesting insects, and corrosion in time.
- Check and confirm that the lightning arrester is in good condition. Replace a new one in time to avoid damaging the inverter and even other equipment.



Risk of electric shock! Ensure that all the power is turned off. All the power in the capacitor has been discharged before performing the above operations.

10 Specifications

Parameters	IP1000-11-Plus	IP1000-12-Plus
Continuous output power	1000W@35°C@Rated input voltage	
Surge power	2000W@5S	
Surge current when power on	<100A	
Output voltage	110VAC(±3%); 120VAC(-7%~+3%)	220VAC(±3%); 230VAC(-7%~+3%)
Output frequency	50/60Hz±0.2%	
Output wave	Pure Sine Wave	
Output distortion THD	THD≤4%(Resistive load)	THD≤3%(Resistive load)
Load power factor	0.2~1(VA≤continuous output power)	
Rated input voltage	12VDC	
Input voltage range	10.8~16.0VDC	
Rated output efficiency ^①	>87%	>89%
Max. output efficiency ^②	>92% (40% loads)	>93% (40% loads)
Idle current	<0.2A	
No-load current	<0.8A	<1.1A
USB output	5VDC/Max.1A	
RS485 com. port	5VDC/200mA	
Mechanical parameters		
Input terminal	M6	
Dimension (Length x Width x Height)	371×231.5×123mm	
Mounting dimension	345×145mm	
Mounting Holes	Φ6mm	
Net Weight	5.8kg	

- ① It means the rated output efficiency when the load power is continuous output power under the rated DC input voltage. (25°C)
- ② It means the max. output efficiency when the inverter is connected with different loads under the rated DC input voltage.

Parameters	IP1000-21-Plus	IP1000-22-Plus
Continuous output power	1000W@35°C@Rated input voltage	
Surge power	2000W@5S	
Surge current when power on	<100A	
Output voltage	110VAC(±3%); 120VAC(-7%~+3%)	220VAC(±3%); 230VAC(-7%~+3%)
Output frequency	50/60Hz±0.2%	
Output wave	Pure Sine Wave	
Output distortion THD	THD≤3%(Resistive load)	
Load power factor	0.2~1(VA≤continuous output power)	
Rated input voltage	24VDC	
Input voltage range	21.6~32.0VDC	
Rated output efficiency ^①	>90%	
Max. output efficiency ^②	>92.5% (30% loads)	>93% (30% loads)
Idle current	<0.2A	
No-load current	<0.6A	<0.9A
USB output	5VDC/Max.1A	
RS485 com. port	5VDC/200mA	
Mechanical parameters		
Input terminal	M6	
Dimension (Length x Width x Height)	371×231.5×123mm	
Mounting dimension	345×145mm	
Mounting Holes	Φ6mm	
Net Weight	5kg	

- ① It means the rated output efficiency when the load power is continuous output power under the rated DC input voltage. (25°C)
- ② It means the max. output efficiency when the inverter is connected with different loads under the rated DC input voltage.

Parameters	IP1500-11-Plus	IP1500-12-Plus
Continuous output power	1500W@35°C@Rated input voltage	
Surge power	3000W@5S	
Surge current when power on	< 100A	
Output voltage	110VAC(±3%); 120VAC(-7%~+3%)	220VAC(±3%); 230VAC(-7%~+3%)
Output frequency	50/60Hz±0.2%	
Output wave	Pure Sine Wave	
Output distortion THD	THD≤4%(Resistive load)	THD≤3%(Resistive load)
Load power factor	0.2~1(VA≤output continuous power)	
Rated input voltage	12VDC	
Input voltage range	10.8~16.0VDC	
Rated output efficiency ^①	> 88%	> 89%
Max. output efficiency ^②	>93%(30% loads)	
Idle current	< 0.2A	
No-load current	< 1.0A	< 1.2A
USB output	5VDC/ Max.1A	
RS485 com. port	5VDC/ 200mA	
Mechanical parameters		
Input terminal	M6	
Dimension (Length x Width x Height)	387×231.5×123mm	
Mounting dimension	361×145mm	
Mounting Holes	Φ6mm	
Net Weight	6kg	

- ① It means the rated output efficiency when the load power is continuous output power under the rated DC input voltage. (25°C)
- ② It means the max. output efficiency when the inverter is connected with different loads under the rated DC input voltage.

Parameters	IP1500-21-Plus	IP1500-22-Plus
Continuous output power	1500W@35°C@Rated input voltage	
Surge power	3000W@5S	
Surge current when power on	<100A	
Output voltage	110VAC(±3%); 120VAC(-7%~+3%)	220VAC(±3%); 230VAC(-7%~+3%)
Output frequency	50/60Hz±0.2%	
Output wave	Pure Sine Wave	
Output distortion THD	THD≤4%(Resistive load)	THD≤3%(Resistive load)
Load power factor	0.2~1(VA≤output continuous power)	
Rated input voltage	24VDC	
Input voltage range	21.6~32.0VDC	
Rated output efficiency ^①	>88%	>90%
Max. output efficiency ^②	>92.5%(30% loads)	>93.5%(30% loads)
Idle current	<0.2A	
No-load current	<0.9A	
USB output	5VDC/ Max.1A	
RS485 com. port	5VDC/ 200mA	
Mechanical parameters		
Input terminal	M6	
Dimension (Length x Width x Height)	387×231.5×123mm	
Mounting dimension	361×145mm	
Mounting Holes	Φ6mm	
Net Weight	6kg	

- ① It means the rated output efficiency when the load power is continuous output power under the rated DC input voltage. (25°C)
- ② It means the max. output efficiency when the inverter is connected with different loads under the rated DC input voltage.

Parameters	IP1500-41-Plus	IP1500-42-Plus
Continuous output power	1500W@35°C@Rated input voltage	
Surge power	3000W@5S	
Surge current when power on	< 50A	
Output voltage	110VAC(±3%); 120VAC(-7%~+3%)	220VAC(±3%); 230VAC(-7%~+3%)
Output frequency	50/60Hz±0.2%	
Output wave	Pure Sine Wave	
Output distortion THD	THD≤4%(Resistive load)	THD≤3%(Resistive load)
Load power factor	0.2~1(VA≤output continuous power)	
Rated input voltage	48VDC	
Input voltage range	43.2~64.0VDC	
Rated output efficiency ^①	>90%	>92.5%
Max. output efficiency ^②	>92%(30% loads)	>94%(30% loads)
Idle current	< 0.2A	
No-load current	< 0.5A	
RS485 com. port	5VDC/ 200mA	
Mechanical parameters		
Input terminal	M6	
Dimension (Length x Width x Height)	387×231.5×123mm	
Mounting dimension	361×145mm	
Mounting Holes	Φ6mm	
Net Weight	6kg	

- ① It means the rated output efficiency when the load power is continuous output power under the rated DC input voltage. (25°C)

- ② It means the max. output efficiency when the inverter is connected with different loads under the rated DC input voltage.

Parameters	IP2000-11-Plus	IP2000-12-Plus
Continuous output power	2000W@35°C@ Rated input voltage	
Surge power	4000W@5S	
Surge current when power on	< 100A	
Output voltage	110VAC(±3%); 120VAC(-7%~+3%)	220VAC(±3%); 230VAC(-7%~+3%)
Output frequency	50/60Hz±0.2%	
Output wave	Pure Sine Wave	
Output distortion THD	THD≤5%(Resistive load)	THD≤3%(Resistive load)
Load power factor	0.2~1(VA≤ output continuous power)	
Rated input voltage	12VDC	
Input voltage range	10.8~16.0VDC	
Rated output efficiency ^①	>85%	>88%
Max. output efficiency ^②	>92% (30% loads)	>94%(30% loads)
Idle current	< 0.2A	
No-load current	< 1.2A	
USB output	5VDC/Max.1A	
RS485 com. port	5VDC/ 200mA	
Mechanical parameters		
Input terminal	M10	
Dimension (Length x Width x Height)	420×231.5×123mm	
Mounting dimension	395×145mm	
Mounting Holes	Φ6mm	
Net Weight	8kg	

- ① It means the rated output efficiency when the load power is continuous output power under the rated DC input voltage. (25°C)

- ② It means the max. output efficiency when the inverter is connected with different loads under the rated DC input voltage.

Parameters	IP2000-21-Plus	IP2000-22-Plus
Continuous output power	2000W@35°C@Rated input voltage	
Surge power	4000W@5S	
Surge current when power on	<100A	
Output voltage	110VAC(±3%); 120VAC(-7%~+3%)	220VAC(±3%); 230VAC(-7%~+3%)
Output frequency	50/60Hz±0.2%	
Output wave	Pure Sine Wave	
Output distortion THD	THD≤4%(Resistive load)	THD≤3%(Resistive load)
Load power factor	0.2~1(VA≤output continuous power)	
Rated input voltage	24VDC	
Input voltage range	21.6~32.0VDC	
Rated output efficiency ^①	>88%	>91%
Max. output efficiency ^②	>92%(30% loads)	>93%(30% loads)
Idle current	<0.2A	
No-load current	<0.9A	<1.0A
USB output	5VDC/ Max.1A	
RS485 com. port	5VDC/200mA	
Mechanical parameters		
Input terminal	M6	
Dimension (Length x Width x Height)	421×231.5×123mm	
Mounting dimension	395×145mm	
Mounting Holes	Φ6mm	
Net Weight	6.5kg	

- ① It means the rated output efficiency when the load power is continuous output power under the rated DC input voltage. (25°C)

- ② It means the max. output efficiency when the inverter is connected with different loads under the rated DC input voltage.

Parameters	IP2000-41-Plus	IP2000-42-Plus
Continuous output power	2000W@35°C@Rated input voltage	
Surge power	4000W@5S	
Surge current when power on	<50A	
Output voltage	110VAC(±3%); 120VAC(-7%~+3%)	220VAC(±3%); 230VAC(-7%~+3%)
Output frequency	50/60Hz±0.2%	
Output wave	Pure Sine Wave	
Output distortion THD	THD≤4%(Resistive load)	THD≤3%(Resistive load)
Load power factor	0.2~1(VA≤output continuous power)	
Rated input voltage	48VDC	
Input voltage range	43.2~64.0VDC	
Rated output efficiency ^①	>88%	>92.5%
Max. output efficiency ^②	>93% (30% loads)	>94.5% (30% loads)
Idle current	<0.2A	
No-load current	<0.5A	
RS485 com. port	5VDC/ 200mA	
Mechanical parameters		
Input terminal	M6	
Dimension (Length x Width x Height)	421×231.5×123mm	
Mounting dimension	395×145mm	
Mounting Holes	Φ6mm	
Net Weight	6.5kg	

- ① It means the rated output efficiency when the load power is continuous output power under the rated DC input voltage. (25°C)

- ② It means the max. output efficiency when the inverter is connected with different loads under the rated DC input voltage.

Parameters	IP3000-11-Plus	IP3000-12-Plus
Continuous output power	3000W@35°C@Rated input voltage	
Surge power	4800W@1S	6000W@5S
Surge current when power on	< 100A	
Output voltage	110VAC(±3%); 120VAC(-7%~+3%)	220VAC(±3%); 230VAC(-7%~+3%)
Output frequency	50/60Hz±0.2%	
Output wave	Pure Sine Wave	
Output distortion THD	THD≤4%(Resistive load)	THD≤3%(Resistive load)
Load power factor	0.2~1 (VA≤output continuous power)	
Rated input voltage	12VDC	
Input voltage range	10.8~16.0VDC	
Rated output efficiency ^①	> 85%	> 87%
Max. output efficiency ^②	>93% (30% loads)	>94% (30% loads)
Idle current	< 0.2A	
No-load current	< 1.6A	
USB output	5VDC/Max.1A	
RS485 com. port	5VDC/ 200mA	
Mechanical parameters		
Input terminal	M10	
Dimension (Length x Width x Height)	550×274×148mm	557×231.5×123mm
Mounting dimension	525×145mm	532×145mm
Mounting Holes	Φ6mm	
Net Weight	13kg	10.5kg

- ① It means the rated output efficiency when the load power is continuous output power under the rated DC input voltage. (25°C)
- ② It means the max. output efficiency when the inverter is connected with different loads under the rated DC input voltage.

Parameters	IP3000-21-Plus	IP3000-22-Plus
Continuous output power	3000W@35°C@Rated input voltage	
Surge power	6000W@5S	
Surge current when power on	<100A	
Output voltage	110VAC(±3%); 120VAC(-7%~+3%)	220VAC(±3%); 230VAC(-7%~+3%)
Output frequency	50/60Hz±0.2%	
Output wave	Pure Sine Wave	
Output distortion THD	THD≤5%(Resistive load)	THD≤3%(Resistive load)
Load power factor	0.2~1(VA≤output continuous power)	
Rated input voltage	24VDC	
Input voltage range	21.6~32.0VDC	
Rated output efficiency ^①	>87%	>90%
Max. output efficiency ^②	>91.5% (30% loads)	>94% (30% loads)
Idle current	<0.2A	
No-load current	<1A	
USB output	5VDC/Max.1A	
RS485 com. port	5VDC/ 200mA	
Mechanical parameters		
Input terminal	M6	
Dimension (Length x Width x Height)	521×274×148mm	
Mounting dimension	495×145mm	
Mounting Holes	Φ6mm	
Net Weight	8kg	

① It means the rated output efficiency when the load power is continuous output power under the rated DC input voltage. (25°C)

② It means the max. output efficiency when the inverter is connected with different loads under the rated DC input voltage.

Parameters	IP3000-41-Plus	IP3000-42-Plus
Continuous output power	3000W@35°C@Rated input voltage	
Surge power	6000W@5S	
Surge current when power on	<65A	
Output voltage	110VAC(±3%); 120VAC(-7%~+3%)	220VAC(±3%); 230VAC(-7%~+3%)
Output frequency	50/60Hz±0.2%	
Output wave	Pure Sine Wave	
Output distortion THD	THD≤4%(Resistive load)	THD≤3%(Resistive load)
Load power factor	0.2~1(VA≤output continuous power)	
Rated input voltage	48VDC	
Input voltage range	43.2~64.0VDC	
Rated output efficiency ^①	>89.5%	>92.5%
Max. output efficiency ^②	>93.5% (30% loads)	>94.5% (30% loads)
Idle current	<0.2A	
No-load current	<0.4A	<0.5A
RS485 com. port	5VDC/ 200mA	
Mechanical parameters		
Input terminal	M6	
Dimension (Length x Width x Height)	516x231.5x123mm	491x231.5x123mm
Mounting dimension	490x145mm	465x145mm
Mounting Holes	Φ6mm	
Net Weight	8kg	7kg

① It means the rated output efficiency when the load power is continuous output power under the rated DC input voltage. (25°C)

② It means the max. output efficiency when the inverter is connected with different loads under the rated DC input voltage.

Parameters	IP4000-41-Plus	IP4000-42-Plus
Continuous output power	4000W@35°C@Rated input voltage	
Surge power	8000W@5S	
Surge current when power on	<65A	
Output voltage	110VAC(±3%); 120VAC(-7%~+3%)	220VAC(±3%); 230VAC(-7%~+3%)
Output frequency	50/60Hz±0.2%	
Output wave	Pure Sine Wave	
Output distortion THD	THD≤4%(Resistive load)	THD≤3%(Resistive load)
Load power factor	0.2~1 (VA≤continuous output power)	
Rated input voltage	48VDC	
Input voltage range	43.2~64VDC	
Rated output efficiency ^①	>88%	>91%
Max. output efficiency ^②	>93%(30% loads)	>94%(30% loads)
Idle current	<0.2A	
No-load current	<0.6A	
RS485 com. port	5VDC/200mA	
Mechanical parameters		
Input terminal	M6	
Dimension (Length x Width x Height)	521×274×148mm	516×231.5×123mm
Mounting dimension	495×145mm	490×145mm
Mounting Holes	Φ6mm	
Net Weight	12kg	8kg

① It means the rated output efficiency when the load power is continuous output power under the rated DC input voltage. (25°C)

② It means the max. output efficiency when the inverter is connected with different loads under the rated DC input voltage.

Parameters	IP5000-42-Plus
Continuous output power	5000W@35°C@Rated input voltage
Surge power	8000W@5S
Surge current when power on	<65A
Output voltage	220VAC(±3%); 230VAC(-7%~+3%)
Output frequency	50/60Hz±0.2%
Output wave	Pure Sine Wave
Output distortion THD	THD≤3%(Resistive load)
Load power factor	0.2~1(VA≤output continuous power)
Rated input voltage	48VDC
Input voltage range	43.2~64.0VDC
Rated output efficiency ^①	>91%
Max. output efficiency ^②	>94%(30% loads)
Idle current	<0.2A
No-load current	<0.8A
RS485 com. port	5VDC/200mA
Mechanical parameters	
Input terminal	M6
Dimension (Length x Width x Height)	531×231.5×123mm
Mounting dimension	505×145mm
Mounting Holes	Φ6mm
Net Weight	9kg

① It means the rated output efficiency when the load power is continuous output power under the rated DC input voltage. (25°C)

② It means the max. output efficiency when the inverter is connected with different loads under the rated DC input voltage.

Environment parameters

Working temperature	-20°C~+60°C(Refer to the Reduced capacity curve)
Storage temperature	-35°C~ +70°C
Relative humidity	< 95%(N.C.)
Enclosure	IP20
Altitude	< 5000m (If the altitude is more than 1000 meters, the rated power will be reduced according to GB7260.)

Appendix 1 Disclaimers

The warranty does not apply to the following conditions:

- Damage is caused by improper use or an inappropriate environment.
- Load current/voltage/power exceeds the limit value of the inverter.
- Damage caused by working temperature exceeds the rated range.
- Arc, fire, explosion, and other accidents are caused by failure to follow the inverter stickers or manual instructions.
- Disassemble and repair the inverter without authorization.
- Damage is caused by force majeure.
- Damage occurred during transportation or handling.

Any changes without prior notice! Version number: V1.4

HUIZHOU EPEVER TECHNOLOGY CO., LTD.

Beijing Tel: 010-82894896/82894112

Huizhou Tel: 0752-3889706

E-mail: webmaster@epsolarpv.com

Website: www.epsolarpv.com

www.epever.com