

# AccuForce 12V - 35Ah S

## Solar VRLA Battery



### Specifications

Nominal Voltage	12 V	
Number of cells	6	
Cycle Life	Approx. 800 cycles at 50% DOD	
Dimensions	Length	195 mm
	Width	130 mm
	Height	155 mm
	Total Height	166 mm
Approx. Weight	9.5 kg	
Nominal Capacity (25°C)	120 hours rate (0.30 A, 11.1 V)	36.0 Ah
	100 hours rate (0.35 A, 11.1 V)	35.0 Ah
	20 hours rate (1.73 A, 10.8 V)	34.6 Ah
	10 hours rate (3.30 A, 10.8 V)	33.0 Ah
	5 hours rate (5.78 A, 10.5 V)	28.9 Ah
Max. Discharge Current (25°C)	330 A (5s)	
Internal Resistance	10 mOhms	
Fully Charged battery (25°C)	3% of capacity declined per month at 25°C (average)	
Operating Temperature Range	Discharge	-15°C~50°C
	Charge	-10°C~50°C
	Storage	-20°C~50°C
Short Circuit Current	1200 A	
Charging Characteristics (25°C)	Cycle use	2.40-2.48 Vpc
	Maximum charging current	10 A
	Temperature compensation	-30 mV/°C
	Standby use	2.27-2.35 Vpc
Temperature compensation	-18 mV/°C	
Design Floating Life (20°C)	10 years	

### Applications

- Solar / Wind power systems
- Residential installations
- Golf carts and electric powered vehicles
- Marine equipment
- Electric wheelchairs
- Traffic systems (signaling and lighting)
- Remote monitoring and controlling
- Power tools and cleaning machines
- Uninterruptible power supply (UPS)

### Battery Construction

Component	Positive Plate	Negative Plate	Container	Cover	Safety Valve	Terminal	Separator	Electrolyte
Raw material	Lead dioxide	Lead	ABS	ABS	Rubber	Copper	Fiberglass	Sulfuric acid

### Dimensions

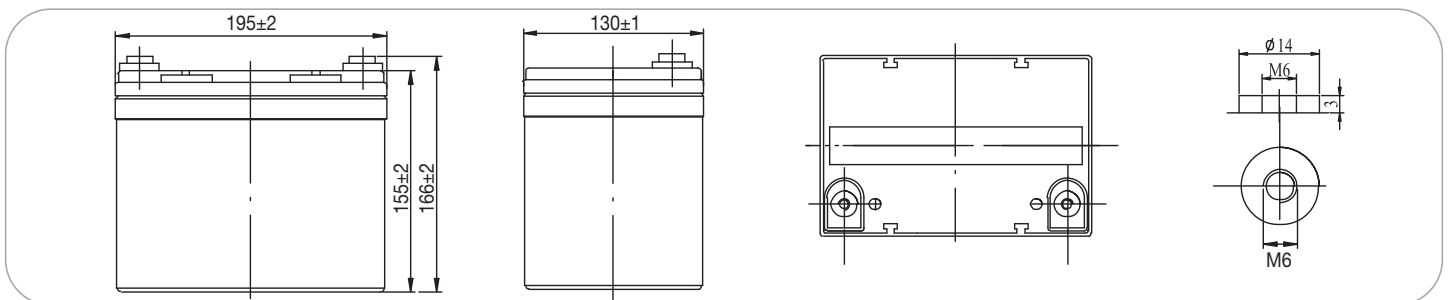

### Constant Current Discharge (Amperes) at 25°C

End Voltage (Volts/Cell)	15min	30min	1h	2h	3h	4h	5h	6h	8h	10h	20h	48h	72h	100h	120h
1.60 V	55.1	33.3	20.6	12.0	8.42	6.90	5.91	5.12	4.03	3.37	1.76	----	----	----	----
1.65 V	53.8	32.7	20.4	12.0	8.38	6.86	5.84	5.05	4.03	3.37	1.76	----	----	----	----
1.70 V	51.8	31.7	19.8	11.9	8.32	6.80	5.81	5.05	3.99	3.33	1.76	0.76	----	----	----
1.75 V	49.8	30.9	19.4	11.7	8.25	6.77	5.78	5.02	3.96	3.33	1.75	0.76	0.52	----	----
1.80 V	47.2	29.8	18.8	11.4	8.02	6.57	5.61	4.85	3.83	3.30	1.73	0.75	0.51	----	----
1.85 V	44.6	28.2	17.8	10.8	7.60	6.20	5.30	4.60	3.60	3.10	1.60	0.71	0.48	0.35	0.30

### Constant Power Discharge (Watts) at 25°C

End Voltage (Volts/Cell)	15min	30min	1h	2h	3h	4h	5h	6h	8h	10h	20h	48h	72h	100h	120h
1.60 V	604	371	235	139	98.0	80.2	69.3	60.1	47.9	39.9	21.1	----	----	----	----
1.65 V	589	364	232	138	97.7	79.9	68.6	59.4	47.9	39.9	21.1	----	----	----	----
1.70 V	568	354	226	137	97.0	79.2	68.3	59.4	47.5	39.6	21.1	9.14	----	----	----
1.75 V	548	346	222	135	96.4	78.9	67.7	58.7	47.2	39.6	21.0	9.10	6.19	----	----
1.80 V	519	334	215	132	93.7	77.2	66.3	57.4	45.5	39.3	20.8	9.01	6.13	----	----
1.85 V	492	317	204	125	88.8	73.2	62.9	54.4	43.1	37.3	19.7	8.54	5.81	4.21	3.57

Note: The above characteristics data can be obtained within three charge/discharge cycles.

# AccuForce 12V - 35Ah S

## Solar VRLA Battery

### Typical Use Life and Operating Temperature

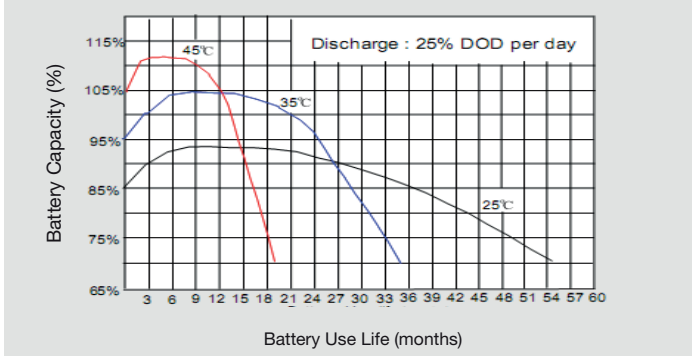

### Self Discharge Characteristics

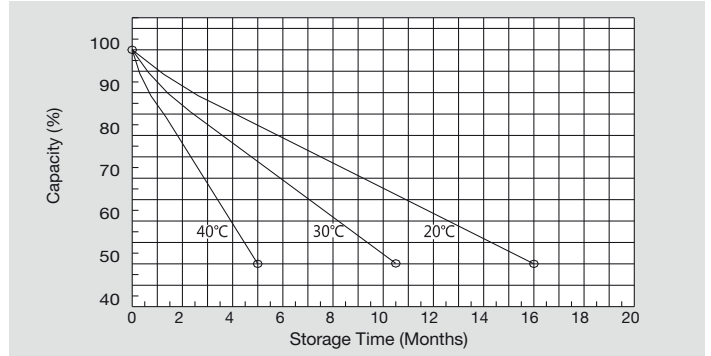

### Discharge Characteristics (25°C)

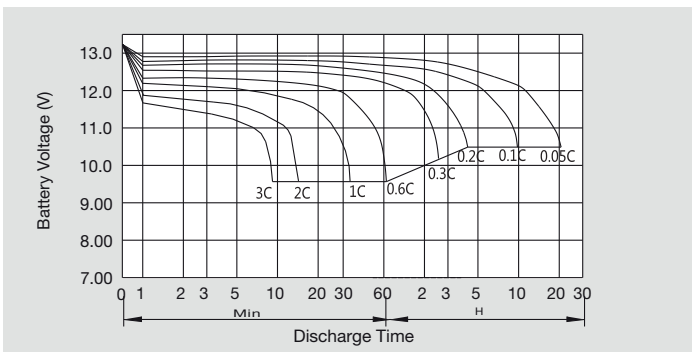

### Charging Characteristics (25°C)

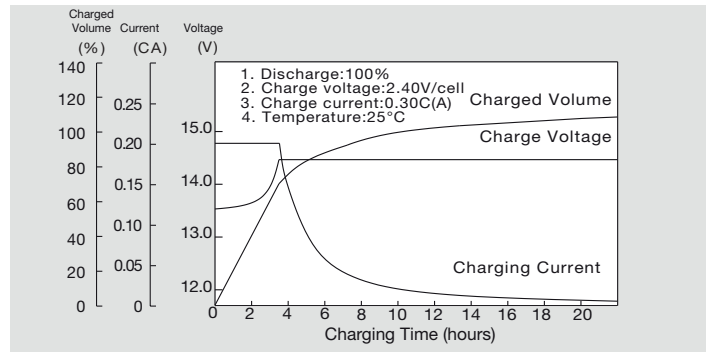

### Relationship Between Charging Voltage and Temperature

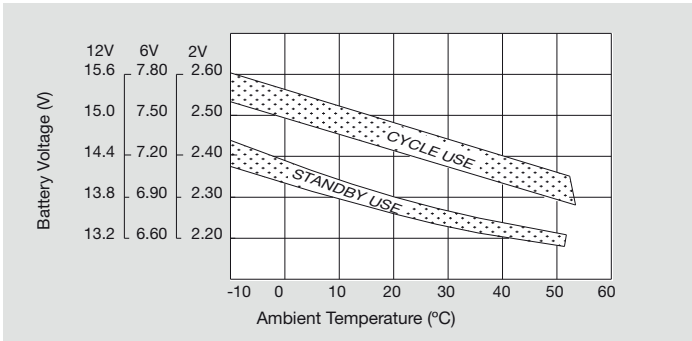

### Relationship Between OCV and Residual Capacity (25°C)

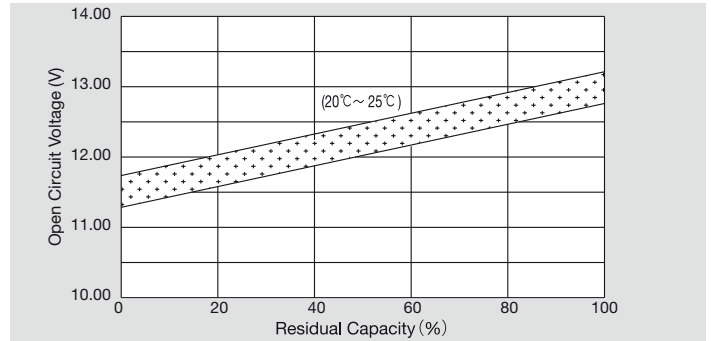

### Cycle Service Life in Relation to Depth of Discharge

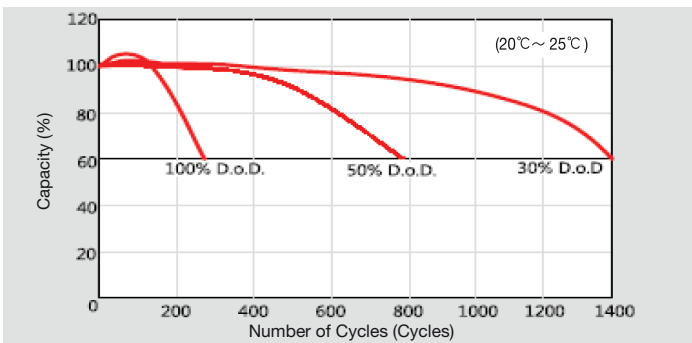

### Temperature Effects on Capacity

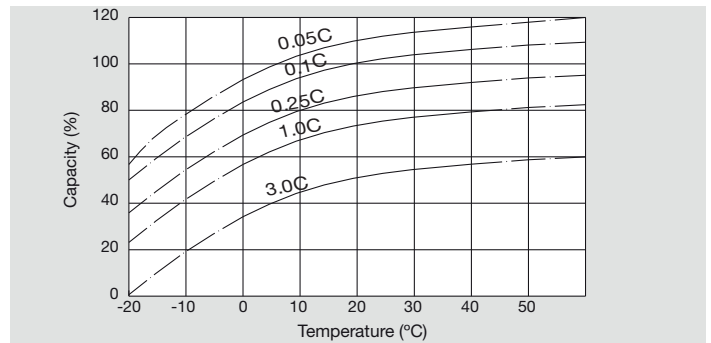

Headquarters 2 Ermou & Nikis Street | Syntagma Square | 105 63 | Athens | Greece | EU  
 Manufacturing Plant Neo Olvio | 672 00 Xanthi | Greece | EU  
 Recycling Plant Industrial Area of Komotini | 691 00 Komotini | Greece | EU  
 Southeast Europe Industrial Sales 14B Menexedon Street | 145 64 Kato Kifissia | Greece | EU  
 European Battery Assembly (SEBA) 175, Via Stra | 37030 Colognola Ai Colli Verona | Italy | EU  
 Industrial SRL 11, Soseaua Centurii | 077025 Bragadiru, Judet Ilfov | Romania | EU

T +30 210 6245400  
 T +30 25410 48100  
 T +30 25310 82460  
 T +30 210 6245600  
 T +39 045 7651771  
 T +40 021 3517777

F +30 210 6245409  
 F +30 25410 95446  
 F +30 25310 82489  
 F +30 210 6245619  
 F +39 045 7651771  
 F +40 021 3516667