

RES SOPzS

Technical Data



BATTERIES



SOLAR PV



WIND



GENSET



GRID



SUNLIGHT

Product Range

2V Cell Type	Capacity (Ah at 20°C)				Dimensions				Weight		Internal Resistance (mOhm)	Short Circuit Current (A)
	C120 Uf=1.85V	C48 Uf=1.80V	C24 Uf=1.80V	C12 Uf=1.75V	Length (mm)	Width (mm)	Height ₁ (mm)	Height ₂ (mm)	Dry (kg)	Wet (kg)		
RES 2 SOPzS 215	215	199	177	156	198	65	408	435	7.4	11.5	1.75	1160
RES 3 SOPzS 310	310	288	257	227	198	83	408	435	10.0	15.4	1.19	1700
RES 3 SOPzS 390	392	365	326	289	198	83	478	505	12.1	18.4	1.02	1980
RES 4 SOPzS 500	503	470	420	375	198	101	478	505	15.4	23.3	0.78	2590
RES 5 SOPzS 605	605	567	508	455	198	119	478	505	18.7	28.0	0.64	3170
RES 4 SOPzS 720	721	688	620	558	198	101	613	640	21.0	30.5	0.63	3190
RES 5 SOPzS 860	860	823	744	673	198	119	613	640	25.6	36.9	0.52	3890
RES 6 SOPzS 965	969	933	846	771	198	137	613	640	30.2	43.4	0.44	4560
RES 7 SOPzS 1270	1271	1206	1084	976	198	174	613	640	35.0	51.6	0.39	5190
RES 8 SOPzS 1380	1382	1318	1188	1075	198	192	613	640	39.6	58.1	0.35	5790

Technical details may be subject to alterations.

Drawings

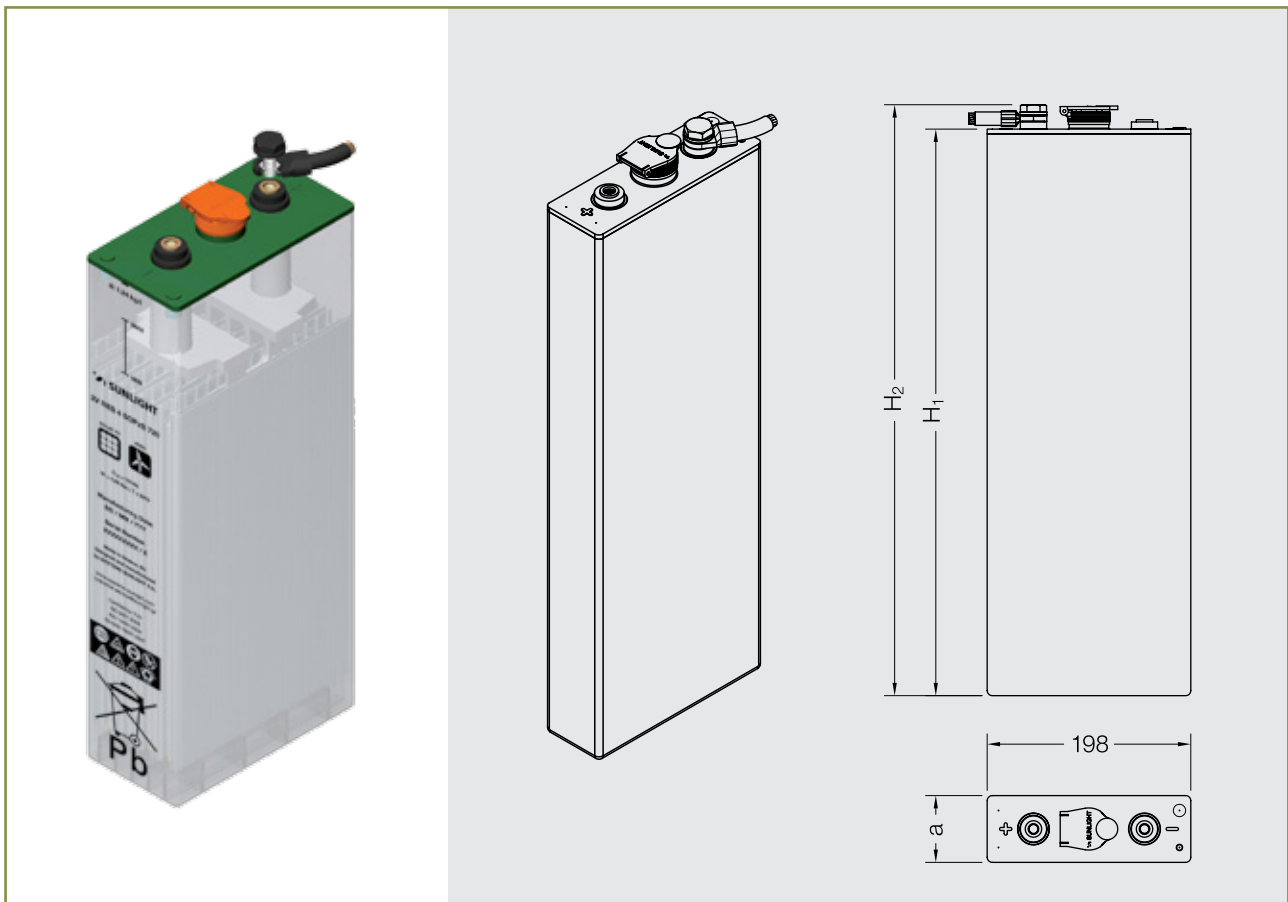

Technical Features

Design

Positive plates	Tubular plates with special low-antimony lead alloy ($\leq 1.65\%$ Sb).
Negative plates	Pasted negative plates of grid design with optimized low-antimony lead alloy.
Separators	Low resistance, microporous PVC.
Electrolyte	Diluted sulphuric acid.
Container, lid material	Polypropylene (translucent for the container) with lid welding, trimming and tightness control.
Poles	Premium design with insert and rubber seal in the lid for hardness and acid resistance. M10 brass inlay. Impedance measurements possible.
Connectors	Accurate voltage measurements possible due to bolt-on type design. Steel bolts with plastic encapsulated heads. Insulated flexible connectors.
Ceramic Plugs	Flame arresting design. Ceramic funnel plugs also available.

Operation

Number of cycles	2000 cycles for 60% DoD at 20°C.
Design life	18 years (stand-by float, 20°C).
Maintenance	Low topping up requirements due to large container and special low-antimony lead alloy plates.
Operating temperature	Recommended 15°C to 35°C. Max: 50°C.
Storage Time	Maximum shelf life up to 3 months at 20°C, 2 months at 30°C or 1 month at 40°C.
Self discharge rate	Approx. 2.5% per month at 20°C.

Certified Quality

- Manufactured at SUNLIGHT's European production facilities, certified with ISO 9001, ISO 14001, BS OHSAS 18001
- Compliant with IEC 61427 requirements for photovoltaic energy systems
- "Long Life" according to Eurobat classification
- Fully compliant with IEC 60896-11 requirements for vented lead-acid batteries
- Compliant with the safety requirements of EN 50272-2 for stationary batteries

Performance Curves

Expected Number of Cycles vs. DoD

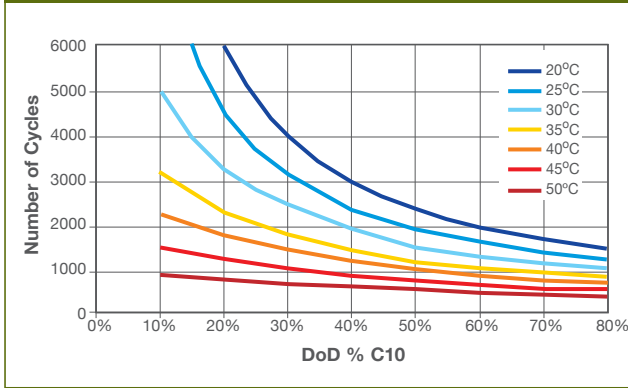

Self-discharge Characteristics

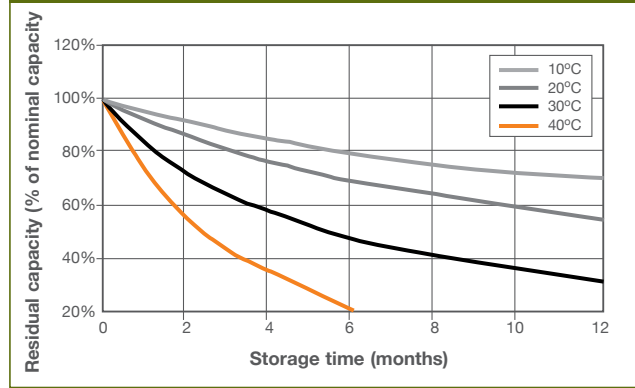

Capacity vs. Temperature

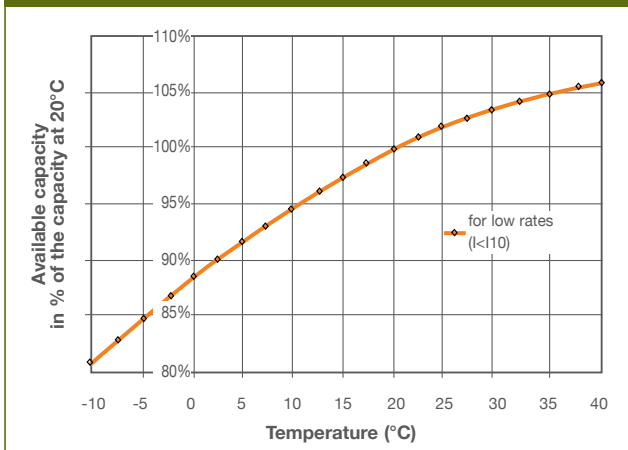

Low-voltage Disconnect Settings

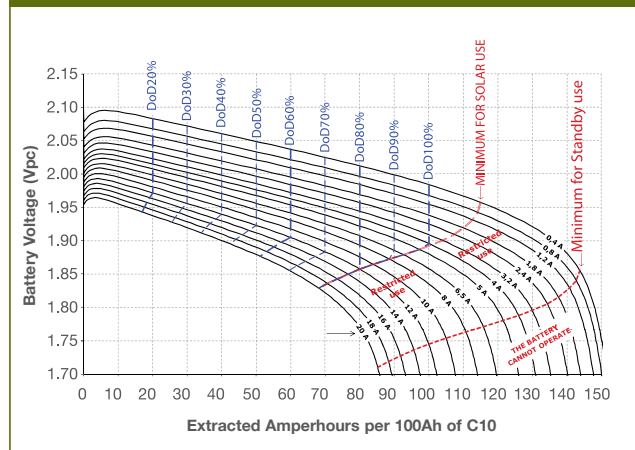

Charging Settings for Stand-alone Systems

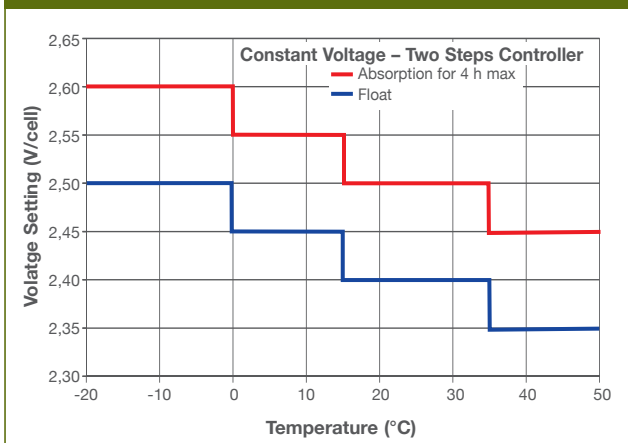

Charging Settings for Hybrid Systems

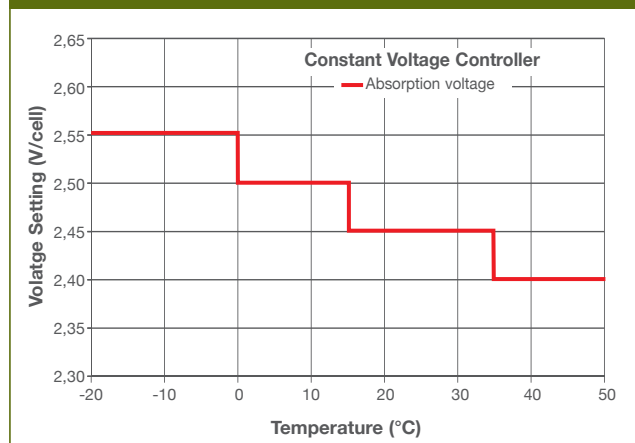

Performance Data

Discharge Constant Current at 20°C (Amperes)

End Voltage 1.60 V/cell												
	1 h	2 h	3 h	4 h	5 h	6 h	7 h	8 h	10 h	12 h	16 h	20 h
RES 2 SOPzS 215	73.64	47.66	36.40	29.87	25.52	22.38	20.00	18.12	15.33	13.34	10.67	8.94
RES 3 SOPzS 310	108.92	70.23	53.52	43.84	37.41	32.78	29.27	26.50	22.40	19.47	15.55	13.01
RES 3 SOPzS 390	139.39	89.87	68.43	56.03	47.78	41.84	37.35	33.81	28.55	24.82	19.80	16.56
RES 4 SOPzS 500	183.29	117.76	89.46	73.12	62.28	54.49	48.59	43.95	37.08	32.19	25.65	21.43
RES 5 SOPzS 605	226.11	144.66	109.60	89.43	76.04	66.46	59.21	53.52	45.09	39.11	31.11	25.96
RES 4 SOPzS 720	274.93	177.10	134.45	109.84	93.55	81.82	72.92	65.91	55.51	48.12	38.23	31.86
RES 5 SOPzS 860	337.92	216.75	164.06	133.75	113.72	99.32	88.41	79.83	67.13	58.12	46.09	38.35
RES 6 SOPzS 965	396.80	253.15	190.89	155.21	131.67	114.79	102.04	92.02	77.22	66.75	52.80	43.86
RES 7 SOPzS 1270	478.63	309.47	235.10	192.13	163.66	143.15	127.59	115.32	97.13	84.21	66.91	55.76
RES 8 SOPzS 1380	537.36	346.13	262.19	213.82	181.82	158.82	141.39	127.67	107.37	92.96	73.73	61.36

End Voltage 1.65 V/cell												
	1 h	2 h	3 h	4 h	5 h	6 h	7 h	8 h	10 h	12 h	16 h	20 h
RES 2 SOPzS 215	72.77	47.27	36.14	29.67	25.36	22.24	19.88	18.02	15.24	13.27	10.61	8.89
RES 3 SOPzS 310	107.54	69.64	53.12	43.54	37.16	32.57	29.08	26.33	22.26	19.35	15.45	12.93
RES 3 SOPzS 390	137.24	89.01	67.87	55.61	47.44	41.56	37.10	33.59	28.37	24.66	19.68	16.46
RES 4 SOPzS 500	180.21	116.57	88.69	72.55	61.81	54.09	48.25	43.65	36.83	31.98	25.49	21.29
RES 5 SOPzS 605	222.15	143.16	108.64	88.71	75.46	65.97	58.79	53.14	44.78	38.85	30.91	25.79
RES 4 SOPzS 720	267.55	174.83	133.09	108.86	92.77	81.17	72.36	65.41	55.10	47.77	37.97	31.64
RES 5 SOPzS 860	328.36	213.86	162.36	132.53	112.74	98.51	87.72	79.22	66.63	57.70	45.76	38.09
RES 6 SOPzS 965	384.67	249.56	188.80	153.72	130.48	113.81	101.19	91.28	76.62	66.24	52.41	43.55
RES 7 SOPzS 1270	463.56	305.14	232.60	190.35	162.25	141.98	126.58	114.44	96.42	83.60	66.44	55.39
RES 8 SOPzS 1380	519.29	341.03	259.28	211.76	180.20	157.48	140.24	126.67	106.55	92.27	73.20	60.93

End Voltage 1.70 V/cell												
	1 h	2 h	3 h	4 h	5 h	6 h	7 h	8 h	10 h	12 h	16 h	20 h
RES 2 SOPzS 215	71.20	46.67	35.76	29.38	25.13	22.05	19.71	17.87	15.12	13.16	10.53	8.82
RES 3 SOPzS 310	105.02	68.69	52.52	43.10	36.80	32.26	28.82	26.10	22.07	19.19	15.33	12.83
RES 3 SOPzS 390	133.16	87.61	67.02	54.99	46.94	41.14	36.74	33.27	28.11	24.44	19.51	16.32
RES 4 SOPzS 500	174.33	114.58	87.50	71.69	61.12	53.52	47.76	43.22	36.48	31.68	25.26	21.10
RES 5 SOPzS 605	214.60	140.63	107.14	87.62	74.60	65.25	58.18	52.60	44.34	38.48	30.62	25.56
RES 4 SOPzS 720	254.20	170.72	130.85	107.32	91.58	80.19	71.53	64.69	54.52	47.29	37.60	31.34
RES 5 SOPzS 860	311.34	208.61	159.51	130.58	111.24	97.28	86.67	78.31	65.90	57.09	45.30	37.72
RES 6 SOPzS 965	363.43	242.94	185.26	151.31	128.64	112.31	99.92	90.18	75.74	65.51	51.86	43.10
RES 7 SOPzS 1270	437.68	297.13	228.38	187.49	160.07	140.21	125.08	113.14	95.38	82.74	65.79	54.86
RES 8 SOPzS 1380	489.01	331.54	254.32	208.43	177.66	155.42	138.51	125.16	105.35	91.28	72.45	60.32

Performance Data

Discharge Constant Current at 20°C (Amperes)

End Voltage 1.75 V/cell												
	1 h	2 h	3 h	4 h	5 h	6 h	7 h	8 h	10 h	12 h	16 h	20 h
RES 2 SOPzS 215	68.13	45.57	35.10	28.91	24.76	21.74	19.45	17.63	14.93	13.00	10.41	8.72
RES 3 SOPzS 310	100.14	66.91	51.48	42.35	36.22	31.78	28.41	25.74	21.78	18.95	15.14	12.67
RES 3 SOPzS 390	125.70	84.87	65.46	53.90	46.10	40.46	36.16	32.76	27.71	24.10	19.25	16.11
RES 4 SOPzS 500	163.85	110.64	85.27	70.14	59.93	52.55	46.94	42.51	35.91	31.21	24.90	20.82
RES 5 SOPzS 605	201.35	135.63	104.32	85.67	73.10	64.04	57.15	51.71	43.64	37.89	30.18	25.20
RES 4 SOPzS 720	234.13	162.56	126.42	104.39	89.39	78.46	70.08	63.45	53.55	46.49	37.01	30.87
RES 5 SOPzS 860	286.10	198.23	153.86	126.85	108.48	95.09	84.85	76.75	64.69	56.09	44.57	37.13
RES 6 SOPzS 965	332.66	230.04	178.18	146.63	125.18	109.58	97.66	88.24	74.24	64.28	50.96	42.39
RES 7 SOPzS 1270	400.59	281.59	219.94	181.99	156.02	137.02	122.45	110.89	93.64	81.31	64.74	54.03
RES 8 SOPzS 1380	446.23	313.29	244.36	201.94	172.90	151.68	135.42	122.54	103.33	89.62	71.24	59.37

End Voltage 1.80 V/cell												
	6 h	7 h	8 h	10 h	12 h	24 h	48 h	72 h	100 h	120 h	168 h	240 h
RES 2 SOPzS 215	21.15	18.95	17.20	14.59	12.72	7.38	4.15	2.92	2.18	1.85	1.36	0.97
RES 3 SOPzS 310	30.83	27.61	25.05	21.23	18.49	10.71	6.00	4.22	3.15	2.67	1.96	1.40
RES 3 SOPzS 390	39.06	34.99	31.76	26.92	23.46	13.58	7.61	5.35	3.99	3.38	2.48	1.77
RES 4 SOPzS 500	50.55	45.26	41.07	34.79	30.29	17.50	9.79	6.88	5.13	4.34	3.18	2.27
RES 5 SOPzS 605	61.51	55.04	49.90	42.22	36.73	21.15	11.81	8.28	6.17	5.23	3.82	2.73
RES 4 SOPzS 720	74.76	67.02	60.85	51.56	44.88	25.82	14.33	9.99	7.38	6.23	4.52	3.20
RES 5 SOPzS 860	90.42	80.98	73.46	62.17	54.06	30.99	17.15	11.93	8.81	7.42	5.39	3.81
RES 6 SOPzS 965	103.76	92.84	84.13	71.09	61.74	35.25	19.44	13.49	9.95	8.38	6.07	4.29
RES 7 SOPzS 1270	130.22	116.84	106.14	90.02	78.40	45.18	25.12	17.52	12.96	10.93	7.94	5.63
RES 8 SOPzS 1380	143.72	128.85	116.96	99.08	86.20	49.52	27.45	19.11	14.12	11.90	8.64	6.11

End Voltage 1.85 V/cell												
	6 h	7 h	8 h	10 h	12 h	24 h	48 h	72 h	100 h	120 h	168 h	240 h
RES 2 SOPzS 215	19.85	17.84	16.24	13.83	12.09	7.07	4.00	2.82	2.11	1.79	1.32	0.94
RES 3 SOPzS 310	28.77	25.85	23.52	20.01	17.48	10.21	5.77	4.07	3.04	2.58	1.90	1.36
RES 3 SOPzS 390	36.14	32.49	29.58	25.19	22.01	12.87	7.28	5.14	3.85	3.27	2.40	1.72
RES 4 SOPzS 500	46.47	41.76	38.00	32.34	28.25	16.50	9.34	6.59	4.94	4.19	3.08	2.21
RES 5 SOPzS 605	56.43	50.67	46.08	39.16	34.18	19.91	11.25	7.94	5.94	5.04	3.70	2.65
RES 4 SOPzS 720	67.79	61.04	55.61	47.39	41.42	24.17	13.61	9.56	7.11	6.01	4.38	3.11
RES 5 SOPzS 860	81.74	73.54	66.95	56.97	49.74	28.95	16.28	11.42	8.48	7.17	5.22	3.71
RES 6 SOPzS 965	93.24	83.79	76.21	64.76	56.48	32.76	18.38	12.88	9.56	8.08	5.88	4.17
RES 7 SOPzS 1270	117.69	106.10	96.75	82.54	72.22	42.30	23.91	16.82	12.52	10.59	7.73	5.49
RES 8 SOPzS 1380	129.34	116.51	106.17	90.48	79.09	46.20	26.07	18.32	13.62	11.52	8.40	5.96

Performance Data

Discharge Constant Current at 20°C (Amperes)

End Voltage 1.90 V/cell												
	6 h	7 h	8 h	10 h	12 h	24 h	48 h	72 h	100 h	120 h	168 h	240 h
RES 2 SOPzS 215	17.49	15.78	14.41	12.33	10.82	6.40	3.66	2.60	1.95	1.66	1.23	0.88
RES 3 SOPzS 310	25.13	22.67	20.69	17.69	15.50	9.16	5.24	3.73	2.80	2.39	1.76	1.27
RES 3 SOPzS 390	31.16	28.15	25.71	22.02	19.32	11.46	6.57	4.68	3.53	3.00	2.22	1.60
RES 4 SOPzS 500	39.66	35.82	32.71	28.00	24.56	14.57	8.38	5.98	4.51	3.85	2.85	2.05
RES 5 SOPzS 605	48.04	43.35	39.56	33.82	29.65	17.56	10.10	7.21	5.44	4.63	3.43	2.47
RES 4 SOPzS 720	56.71	51.36	47.01	40.35	35.47	21.14	12.17	8.65	6.50	5.52	4.07	2.91
RES 5 SOPzS 860	68.13	61.65	56.38	48.34	42.46	25.26	14.54	10.34	7.77	6.60	4.85	3.47
RES 6 SOPzS 965	77.00	69.60	63.61	54.48	47.81	28.41	16.35	11.62	8.72	7.41	5.45	3.89
RES 7 SOPzS 1270	98.07	88.96	81.53	70.12	61.74	37.03	21.48	15.34	11.55	9.83	7.25	5.19
RES 8 SOPzS 1380	107.15	97.11	88.95	76.43	67.24	40.28	23.34	16.66	12.54	10.67	7.86	5.63

End Voltage 1.94 V/cell												
	6 h	7 h	8 h	10 h	12 h	24 h	48 h	72 h	100 h	120 h	168 h	240 h
RES 2 SOPzS 215	14.57	13.21	12.10	10.41	9.17	5.50	3.19	2.28	1.72	1.47	1.09	0.79
RES 3 SOPzS 310	20.72	18.77	17.19	14.78	13.01	7.81	4.54	3.26	2.47	2.11	1.57	1.13
RES 3 SOPzS 390	25.33	22.98	21.07	18.15	16.00	9.67	5.66	4.07	3.09	2.64	1.96	1.42
RES 4 SOPzS 500	31.86	28.90	26.49	22.82	20.13	12.21	7.19	5.19	3.95	3.38	2.52	1.83
RES 5 SOPzS 605	38.53	34.92	31.99	27.53	24.27	14.72	8.68	6.27	4.77	4.09	3.05	2.21
RES 4 SOPzS 720	44.68	40.67	37.39	32.34	28.62	17.54	10.40	7.51	5.70	4.88	3.62	2.61
RES 5 SOPzS 860	53.53	48.68	44.73	38.66	34.20	20.98	12.45	9.00	6.83	5.84	4.34	3.13
RES 6 SOPzS 965	59.94	54.47	50.02	43.22	38.22	23.48	13.95	10.08	7.66	6.54	4.86	3.50
RES 7 SOPzS 1270	77.11	70.32	64.76	56.18	49.84	30.89	18.53	13.46	10.27	8.80	6.55	4.74
RES 8 SOPzS 1380	83.80	76.37	70.29	60.94	54.05	33.51	20.10	14.59	11.12	9.52	7.08	5.12

End Voltage 2.00 V/cell												
	6 h	7 h	8 h	10 h	12 h	24 h	48 h	72 h	100 h	120 h	168 h	240 h
RES 2 SOPzS 215	8.59	7.84	7.23	6.29	5.59	3.49	2.09	1.52	1.16	0.99	0.74	0.54
RES 3 SOPzS 310	11.98	10.94	10.10	8.80	7.83	4.93	2.99	2.18	1.68	1.44	1.07	0.78
RES 3 SOPzS 390	14.22	13.02	12.05	10.55	9.43	6.01	3.69	2.71	2.09	1.79	1.33	0.96
RES 4 SOPzS 500	17.50	16.07	14.90	13.08	11.73	7.59	4.70	3.49	2.69	2.32	1.73	1.24
RES 5 SOPzS 605	21.27	19.53	18.11	15.92	14.28	9.26	5.76	4.27	3.29	2.85	2.12	1.51
RES 4 SOPzS 720	23.92	22.11	20.61	18.26	16.49	10.91	6.87	5.13	3.96	3.41	2.54	1.83
RES 5 SOPzS 860	28.78	26.61	24.83	22.02	19.91	13.20	8.33	6.21	4.80	4.15	3.09	2.20
RES 6 SOPzS 965	31.85	29.49	27.54	24.48	22.17	14.76	9.34	6.92	5.35	4.65	3.48	2.42
RES 7 SOPzS 1270	41.75	38.73	36.24	32.30	29.31	19.76	12.69	9.52	7.45	6.40	4.81	3.54
RES 8 SOPzS 1380	45.20	41.96	39.27	35.02	31.81	21.45	13.74	10.35	8.04	6.92	5.17	3.73

Performance Data

Discharge Constant Power at 20°C (Watts/cell)

End Voltage 1.60 V/cell												
	1 h	2 h	3 h	4 h	5 h	6 h	7 h	8 h	10 h	12 h	16 h	20 h
RES 2 SOPzS 215	127.79	85.44	66.25	54.89	47.21	41.62	37.34	33.95	28.87	25.23	20.30	17.08
RES 3 SOPzS 310	188.58	125.64	97.21	80.40	69.06	60.82	54.53	49.54	42.08	36.74	29.51	24.80
RES 3 SOPzS 390	239.18	159.74	123.63	102.25	87.82	77.33	69.31	62.96	53.47	46.67	37.47	31.49
RES 4 SOPzS 500	313.59	208.78	161.23	133.14	114.19	100.45	89.97	81.67	69.27	60.40	48.43	40.65
RES 5 SOPzS 605	386.50	256.34	197.46	162.77	139.39	122.47	109.59	99.40	84.21	73.35	58.73	49.24
RES 4 SOPzS 720	461.50	310.02	239.92	198.31	170.26	149.82	134.16	121.74	103.16	89.85	71.89	60.22
RES 5 SOPzS 860	566.48	379.11	292.55	241.32	206.84	181.76	162.58	147.38	124.69	108.47	86.62	72.46
RES 6 SOPzS 965	663.70	441.95	339.81	279.56	239.09	209.72	187.32	169.59	143.19	124.36	99.07	82.73
RES 7 SOPzS 1270	798.09	539.38	418.16	345.94	297.18	261.61	234.35	212.70	180.30	157.08	125.73	105.35
RES 8 SOPzS 1380	894.39	602.45	465.76	384.56	329.81	289.92	259.42	235.22	199.07	173.22	138.38	115.80

End Voltage 1.65 V/cell												
	1 h	2 h	3 h	4 h	5 h	6 h	7 h	8 h	10 h	12 h	16 h	20 h
RES 2 SOPzS 215	126.51	84.86	65.86	54.58	46.96	41.40	37.15	33.78	28.73	25.11	20.20	17.00
RES 3 SOPzS 310	186.54	124.75	96.61	79.94	68.68	60.49	54.24	49.28	41.87	36.55	29.37	24.68
RES 3 SOPzS 390	236.04	158.46	122.79	101.61	87.29	76.88	68.92	62.62	53.19	46.42	37.28	31.33
RES 4 SOPzS 500	309.09	206.99	160.08	132.27	113.48	99.84	89.44	81.20	68.89	60.07	48.18	40.44
RES 5 SOPzS 605	380.72	254.09	196.01	161.67	138.50	121.72	108.94	98.82	83.73	72.94	58.41	48.97
RES 4 SOPzS 720	451.07	306.62	237.87	196.82	169.07	148.82	133.30	120.98	102.54	89.32	71.48	59.88
RES 5 SOPzS 860	553.03	374.77	289.98	239.45	205.35	180.51	161.50	146.43	123.92	107.81	86.11	72.05
RES 6 SOPzS 965	646.70	436.57	336.64	277.28	237.27	208.21	186.01	168.45	142.26	123.57	98.47	82.24
RES 7 SOPzS 1270	777.30	532.91	414.37	343.24	295.04	259.82	232.80	211.33	179.19	156.14	125.00	104.75
RES 8 SOPzS 1380	869.56	594.81	461.37	381.43	327.33	287.87	257.64	233.66	197.81	172.15	137.56	115.12

End Voltage 1.70 V/cell												
	1 h	2 h	3 h	4 h	5 h	6 h	7 h	8 h	10 h	12 h	16 h	20 h
RES 2 SOPzS 215	124.16	83.93	65.27	54.13	46.60	41.09	36.88	33.54	28.54	24.94	20.07	16.89
RES 3 SOPzS 310	182.78	123.28	95.68	79.24	68.11	60.02	53.82	48.91	41.57	36.30	29.17	24.52
RES 3 SOPzS 390	230.04	156.28	121.46	100.63	86.51	76.22	68.36	62.11	52.78	46.08	37.01	31.10
RES 4 SOPzS 500	300.50	203.91	158.21	130.90	112.39	98.94	88.65	80.51	68.33	59.60	47.81	40.14
RES 5 SOPzS 605	369.72	250.17	193.66	159.95	137.14	120.59	107.96	97.96	83.03	72.35	57.95	48.60
RES 4 SOPzS 720	432.73	300.29	234.36	194.38	167.18	147.26	131.98	119.82	101.61	88.54	70.88	59.40
RES 5 SOPzS 860	529.66	366.69	285.51	236.38	202.97	178.56	159.84	144.98	122.76	106.84	85.38	71.45
RES 6 SOPzS 965	617.69	426.38	331.08	273.47	234.34	205.82	183.99	166.68	140.85	122.40	97.58	81.52
RES 7 SOPzS 1270	742.42	520.65	407.78	338.73	291.58	257.00	230.41	209.25	177.53	154.75	123.94	103.90
RES 8 SOPzS 1380	828.96	580.30	453.59	376.17	323.30	284.60	254.88	231.26	195.90	170.55	136.35	114.15

Performance Data

Discharge Constant Power at 20°C (Watts/cell)

End Voltage 1.75 V/cell												
	1 h	2 h	3 h	4 h	5 h	6 h	7 h	8 h	10 h	12 h	16 h	20 h
RES 2 SOPzS 215	119.60	82.17	64.21	53.37	45.99	40.59	36.45	33.16	28.23	24.68	19.87	16.72
RES 3 SOPzS 310	175.57	120.45	93.99	78.03	67.16	59.22	53.14	48.32	41.08	35.89	28.85	24.26
RES 3 SOPzS 390	219.29	151.96	118.94	98.87	85.14	75.10	67.40	61.28	52.11	45.51	36.58	30.75
RES 4 SOPzS 500	285.43	197.71	154.61	128.38	110.45	97.35	87.31	79.33	67.39	58.81	47.21	39.65
RES 5 SOPzS 605	350.71	242.29	189.10	156.77	134.68	118.59	106.27	96.49	81.86	71.37	57.21	48.00
RES 4 SOPzS 720	404.93	287.82	227.27	189.63	163.61	144.42	129.60	117.78	100.01	87.22	69.90	58.62
RES 5 SOPzS 860	494.72	350.86	276.50	230.33	198.44	174.95	156.84	142.41	120.75	105.18	84.15	70.48
RES 6 SOPzS 965	575.00	406.75	319.80	265.88	228.68	201.32	180.25	163.49	138.37	120.36	96.08	80.34
RES 7 SOPzS 1270	691.58	497.16	394.37	329.83	284.97	251.77	226.07	205.55	174.64	152.38	122.20	102.52
RES 8 SOPzS 1380	770.20	552.83	437.81	365.66	315.53	278.45	249.80	226.92	192.54	167.80	134.33	112.56

End Voltage 1.80 V/cell												
	6 h	7 h	8 h	10 h	12 h	24 h	48 h	72 h	100 h	120 h	168 h	240 h
RES 2 SOPzS 215	21.15	18.95	17.20	14.59	12.72	7.38	4.15	2.92	2.18	1.85	1.36	0.97
RES 3 SOPzS 310	30.83	27.61	25.05	21.23	18.49	10.71	6.00	4.22	3.15	2.67	1.96	1.40
RES 3 SOPzS 390	39.06	34.99	31.76	26.92	23.46	13.58	7.61	5.35	3.99	3.38	2.48	1.77
RES 4 SOPzS 500	50.55	45.26	41.07	34.79	30.29	17.50	9.79	6.88	5.13	4.34	3.18	2.27
RES 5 SOPzS 605	61.51	55.04	49.90	42.22	36.73	21.15	11.81	8.28	6.17	5.23	3.82	2.73
RES 4 SOPzS 720	74.76	67.02	60.85	51.56	44.88	25.82	14.33	9.99	7.38	6.23	4.52	3.20
RES 5 SOPzS 860	90.42	80.98	73.46	62.17	54.06	30.99	17.15	11.93	8.81	7.42	5.39	3.81
RES 6 SOPzS 965	103.76	92.84	84.13	71.09	61.74	35.25	19.44	13.49	9.95	8.38	6.07	4.29
RES 7 SOPzS 1270	130.22	116.84	106.14	90.02	78.40	45.18	25.12	17.52	12.96	10.93	7.94	5.63
RES 8 SOPzS 1380	143.72	128.85	116.96	99.08	86.20	49.52	27.45	19.11	14.12	11.90	8.64	6.11

End Voltage 1.85 V/cell												
	6 h	7 h	8 h	10 h	12 h	24 h	48 h	72 h	100 h	120 h	168 h	240 h
RES 2 SOPzS 215	37.37	33.71	30.77	26.32	23.09	13.69	7.84	5.57	4.19	3.57	2.64	1.90
RES 3 SOPzS 310	54.10	48.76	44.49	38.03	33.34	19.73	11.29	8.03	6.04	5.14	3.80	2.74
RES 3 SOPzS 390	67.77	61.15	55.82	47.76	41.89	24.83	14.23	10.13	7.63	6.50	4.80	3.46
RES 4 SOPzS 500	87.04	78.49	71.62	61.23	53.68	31.78	18.23	12.98	9.78	8.33	6.16	4.44
RES 5 SOPzS 605	105.70	95.24	86.84	74.15	64.96	38.36	21.97	15.64	11.78	10.03	7.42	5.34
RES 4 SOPzS 720	126.50	114.30	104.44	89.43	78.47	46.46	26.55	18.81	14.09	11.96	8.79	6.29
RES 5 SOPzS 860	152.55	137.71	125.73	107.50	94.23	55.64	31.76	22.48	16.83	14.28	10.49	7.50
RES 6 SOPzS 965	173.90	156.81	143.04	122.12	106.92	62.92	35.85	25.35	18.96	16.09	11.80	8.43
RES 7 SOPzS 1270	219.42	198.50	181.54	155.65	136.72	81.27	46.68	33.16	24.89	21.15	15.55	11.14
RES 8 SOPzS 1380	241.08	217.91	199.15	170.55	149.67	88.73	50.88	36.11	27.07	22.99	16.90	12.09

Performance Data

Discharge Constant Power at 20°C (Watts/cell)

End Voltage 1.90 V/cell												
	6 h	7 h	8 h	10 h	12 h	24 h	48 h	72 h	100 h	120 h	168 h	240 h
RES 2 SOPzS 215	33.25	30.10	27.55	23.67	20.83	12.47	7.21	5.15	3.89	3.32	2.47	1.78
RES 3 SOPzS 310	47.75	43.20	39.52	33.92	29.83	17.84	10.33	7.39	5.60	4.78	3.55	2.57
RES 3 SOPzS 390	59.13	53.55	49.04	42.15	37.11	22.27	12.94	9.28	7.03	6.01	4.47	3.24
RES 4 SOPzS 500	75.22	68.10	62.34	53.56	47.13	28.30	16.49	11.86	9.00	7.70	5.73	4.15
RES 5 SOPzS 605	91.13	82.44	75.41	64.71	56.90	34.12	19.88	14.29	10.85	9.28	6.91	5.01
RES 4 SOPzS 720	107.37	97.48	89.42	77.05	67.94	40.99	23.91	17.15	12.97	11.06	8.20	5.91
RES 5 SOPzS 860	129.00	117.01	107.26	92.30	81.33	49.00	28.60	20.51	15.51	13.23	9.80	7.06
RES 6 SOPzS 965	145.78	132.09	120.98	103.99	91.54	55.09	32.15	23.05	17.42	14.86	11.00	7.92
RES 7 SOPzS 1270	185.60	168.76	155.01	133.82	118.19	71.81	42.25	30.45	23.11	19.74	14.67	10.58
RES 8 SOPzS 1380	202.77	184.23	169.10	145.84	128.71	78.09	45.92	33.07	25.08	21.42	15.90	11.46

End Voltage 1.94 V/cell												
	6 h	7 h	8 h	10 h	12 h	24 h	48 h	72 h	100 h	120 h	168 h	240 h
RES 2 SOPzS 215	28.05	25.48	23.39	20.19	17.83	10.81	6.33	4.55	3.46	2.96	2.21	1.60
RES 3 SOPzS 310	39.89	36.21	33.22	28.64	25.29	15.35	9.02	6.51	4.96	4.25	3.18	2.31
RES 3 SOPzS 390	48.71	44.28	40.67	35.14	31.07	18.97	11.22	8.13	6.21	5.32	3.98	2.90
RES 4 SOPzS 500	61.27	55.67	51.13	44.17	39.05	23.94	14.26	10.37	7.94	6.82	5.11	3.73
RES 5 SOPzS 605	74.10	67.28	61.75	53.30	47.11	28.87	17.22	12.54	9.60	8.25	6.18	4.51
RES 4 SOPzS 720	85.88	78.29	72.09	62.54	55.47	34.36	20.62	15.01	11.47	9.84	7.35	5.34
RES 5 SOPzS 860	102.89	93.73	86.26	74.76	66.30	41.10	24.71	17.99	13.76	11.80	8.82	6.41
RES 6 SOPzS 965	115.20	104.86	96.45	83.55	74.08	45.99	27.68	20.16	15.42	13.22	9.88	7.17
RES 7 SOPzS 1270	148.18	135.35	124.84	108.60	96.57	60.50	36.77	26.94	20.69	17.79	13.33	9.71
RES 8 SOPzS 1380	161.05	146.99	135.51	117.80	104.73	65.61	39.88	29.21	22.41	19.26	14.43	10.50

End Voltage 2.00 V/cell												
	6 h	7 h	8 h	10 h	12 h	24 h	48 h	72 h	100 h	120 h	168 h	240 h
RES 2 SOPzS 215	16.92	15.47	14.28	12.45	11.09	6.97	4.22	3.09	2.37	2.03	1.52	1.12
RES 3 SOPzS 310	23.59	21.58	19.93	17.40	15.52	9.85	6.03	4.44	3.43	2.94	2.20	1.61
RES 3 SOPzS 390	27.99	25.67	23.78	20.85	18.67	12.00	7.42	5.49	4.28	3.65	2.74	1.99
RES 4 SOPzS 500	34.42	31.64	29.36	25.83	23.21	15.13	9.50	7.09	5.50	4.74	3.56	2.58
RES 5 SOPzS 605	41.83	38.44	35.69	31.42	28.25	18.48	11.62	8.69	6.74	5.82	4.36	3.15
RES 4 SOPzS 720	47.00	43.48	40.57	36.02	32.60	21.76	13.87	10.41	8.11	6.98	5.24	3.80
RES 5 SOPzS 860	56.53	52.33	48.85	43.42	39.32	26.33	16.81	12.64	9.82	8.50	6.36	4.57
RES 6 SOPzS 965	62.51	57.93	54.16	48.23	43.76	29.43	18.82	14.07	10.93	9.58	7.15	5.02
RES 7 SOPzS 1270	81.99	76.14	71.29	63.67	57.88	39.37	25.57	19.33	15.20	13.13	9.94	7.40
RES 8 SOPzS 1380	88.72	82.43	77.22	69.02	62.78	42.76	27.75	20.99	16.49	14.18	10.68	7.79

SYSTEMS SUNLIGHT S.A.

Headquarters

2 Ermou & Nikis Str., Syntagma Sq.
105 63 Athens, Attica, Greece

T +30 210 6245400

F +30 210 6245409

European Manufacturing Plant

Neo Olvio
672 00 Xanthi, Greece

T +30 25410 48100

F +30 25410 95446

Global Service Department

366 Tatoiou Str.
136 73 Acharnes, Attica, Greece

T +30 210 6245600

F +30 210 6245619

www.systems-sunlight.com



Member of SUNLIGHT Global Partners Network